

Tensione massima	250 Vca, 24 Vcc; 30 V con opzione "G"	Max. voltage	250 Vac, 24 Vdc; 30 V with "G" option
Tensione di lavoro	220 Vca	Working voltage	220 Vac
Intensità di corrente	3 A (resistivi), 2 A (induttivi)	Current	3 A (resistive), 2 A (inductive)
Contatti elettrici	SPDT	Electrical contacts	SPDT
N° cicli max. a pistone	60/1'	Max. cycle rate - piston type	60/min.
Protezione	IP 65 - DIN 40050 vedi pagina 8	Protection	IP 65 - DIN 40050 see page 8
Connettore	DIN 43650 forma A PG09 o PG11	Connector	DIN 43650 form A PG09 or PG11
Materiale corpo	Alluminio anodizzato	Body material	Anodized aluminium
Differenziale fisso max. 25°C	30% del valore di taratura (o 10% F.S.)	Max. fixed hysteresis at 25°C	30% of set-point (or 10% F.S.)

CONNESSIONI ELETTRICHE DISPONIBILI / AVAILABLE ELECTRICAL CONNECTIONS

PROTEZIONE IP 65 / IP 65 PROTECTION

Connettore DIN 43650 A
DIN 43650 A connector

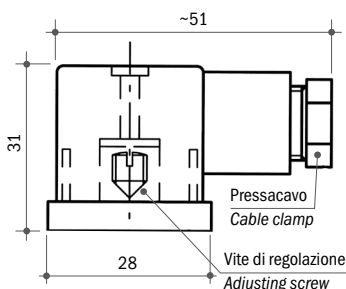

Connettore trasparente con Led bicolore rosso/verde
Transparent connector with red/green bi-coloured led

Tipo **CLB**
Type

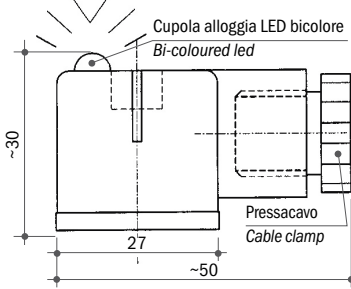

Adattatore DIN 43650 A a M12
DIN 43650 A to M12 adaptor

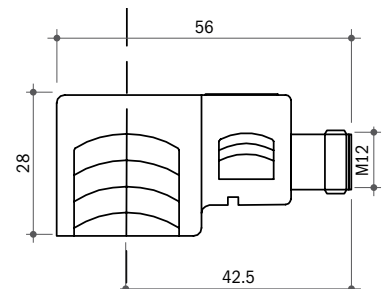

SIGLA DI ORDINAZIONE / HOW TO ORDER

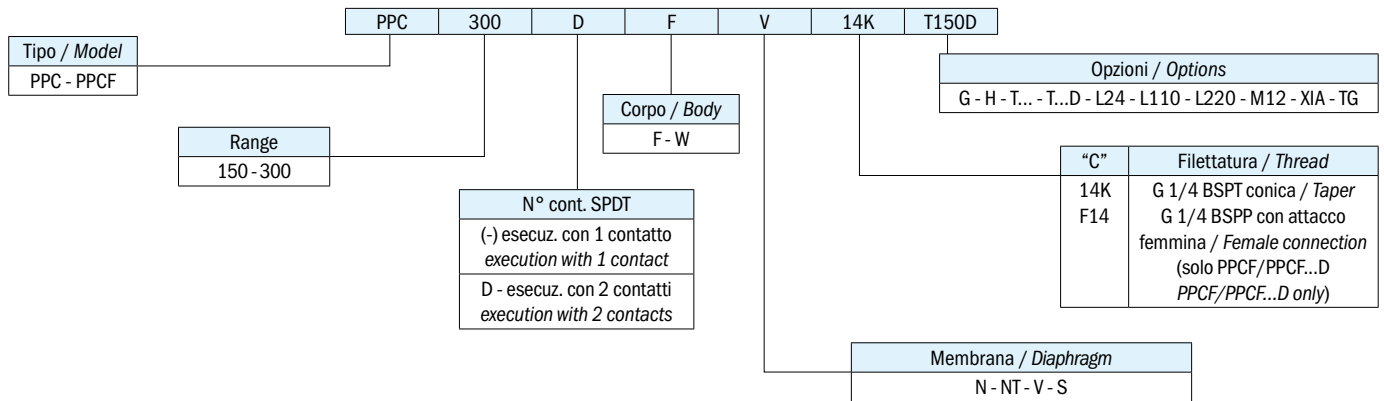

SPIEGAZIONE DELLE SIGLE DI ORDINAZIONE / ORDERING INFORMATION

PPC...	Pressostato a pistone con contatti in scambio		
PPCF...	Pressostato a pistone con contatti in scambio e attacco femmina		
PPC...D	Pressostato a pistone con 2 contatti in scambio		
PPCF...D	Pressostato a pistone con 2 contatti in scambio e attacco femmina		
Materiale flangia Ch 30 (vedi caratteristiche generali)	F	Acciaio zincato	
	W	Acciaio Inox AISI 316 a richiesta su tutti i modelli	
Membrana disponibile/guarnizione	N	NBR (standard) (-5°C...+80°C)	
	NT	HNBR (-25°C...+140°C)	
	V	FKM (-5°C...+90°C)	
	S	Silicone (-30°C...+120°C)	
Filettature disponibili	14K	G 1/4 BSPT conica	
	F14	G 1/4 BSPP con attacco femmina (solo PPCF/PPCF...D)	
Opzioni	G	Contatti dorati per bassa corrente	
	H	Microinterruttore da 10 A	
	T...	Taratura in salita al valore richiesto (es. T50 taratura in salita a 50 bar)	
	T...D	Taratura in discesa al valore richiesto (es. T70D taratura in discesa a 70 bar)	
	L24	Con lampada 24 V	
	L110	Con lampada 110 V	
	L220	Con lampada 220 V	
	M12	Con connettore M12	
	XIA	Esecuzione XIA - Certificato ATEX Ex ia IIC T6/T5/T4 Ga e IECEx Ex ia IIC T6/T5/T4 Ga	
	TG	Testati per utilizzo con gas	

PPC...	Piston pressure switch with SPDT contacts		
PPCF...	Piston pressure switch with SPDT contacts and female connection		
PPC...D	Piston pressure switch with 2 SPDT contacts		
PPCF...D	Piston pressure switch with 2 SPDT contacts and female connection		
Flange material 30 AF (see general specifications)	F	Zinc plated steel	
	W	S.s. 316 on request for all models	
Available diaphragm/seal	N	NBR (standard) (-5°C to +80°C)	
	NT	HNBR (-25°C to +140°C)	
	V	FKM (-5°C to +90°C)	
	S	Silicone (-30°C to +120°C)	
Available threads	14K	G 1/4 BSPT taper	
	F14	G 1/4 BSPP female connection (PPCF/PPCF...D only)	
Options	G	Gold-plated contacts for low current	
	H	Microswitch for 10 A	
	T...	Set-point rising to the required value (ex. T50 rising set-point adjustment at 50 bar)	
	T...D	Set-point falling to the required value (ex. T70D falling set-point adjustment at 70 bar)	
	L24	Connector with LED 24 V	
	L110	Connector with LED 110 V	
	L220	Connector with LED 220 V	
	M12	Connector with M12	
	XIA	XIA execution - Certified ATEX Ex ia IIC T6/T5/T4 Ga and IECEx Ex ia IIC T6/T5/T4 Ga	
	TG	Tested for applications with gas	

CARATTERISTICHE GENERALI / GENERAL SPECIFICATIONS

TIPO MODEL	CAMPO DI REGOLAZIONE ADJUSTMENT RANGE bar	DIMENSIONI DIMENSIONS mm				TOLLERANZA D'INTERVENTO 25°C TOLERANCE AT 25°C bar	MAX. PRESSIONE STATICA SUPPORTABILE MAX. STATIC PRESSURE bar	ESECUZIONE EXECUTION
		A	B	C	D			
PPC150	30 - 150	46	12	G 1/4 BSPT	78	± 7.0	600	Pistone in acciaio Steel piston
PPC300	150 - 300							
PPCF150	30 - 150	72	12	G 1/4 BSPP femmina female	92	± 7.0	600	Pistone in acciaio Steel piston
PPCF300	150 - 300							

Elettrotec si riserva la facoltà di apportare modifiche tecniche ai prodotti o di cessarne la produzione senza obbligo di preavviso. Il contatto del pressostato può danneggiarsi quando sottoposto a forti urti o ad alte vibrazioni. È responsabilità dell'utilizzatore verificare l'idoneità dei nostri prodotti per ogni particolare applicazione (ad esempio, la verifica della compatibilità dei materiali) e l'uso può essere appropriato solo se dimostrato in test sul campo. Le informazioni tecniche in questo catalogo si basano su prove effettuate durante lo sviluppo del prodotto e in base ai valori empiricamente raccolti. Essi non possono essere applicabili in tutti i casi.

Elettrotec reserves the right to technical data of change to the products or halt production without prior notice. The pressure switch contacts can be damaged when subject to strong shocks or high vibration. It is the responsibility of the user to test the suitability of our products for the particular application, for example, the verification of material compatibility. The use may only be appropriate if proven in field tests. The technical information in this catalogue are based on tests made during product development and based on empirically gathered values. They may not be applicable in all cases.

DATI TECNICI GENERALI GENERAL TECHNICAL DATA

PRESSOSTATO A MEMBRANA, CONTATTO NC
DIAPHRAGM PRESSURE SWITCH, NC CONTACT

SENZA PRESSIONE
WITHOUT PRESSURE



CON PRESSIONE
WITH PRESSURE

PRESSOSTATO A MEMBRANA, CONTATTO NA
DIAPHRAGM PRESSURE SWITCH, NO CONTACT

SENZA PRESSIONE
WITHOUT PRESSURE



CON PRESSIONE
WITH PRESSURE

COPIE DI SERRAGGIO CONSIGLIATE / RECOMMENDED TIGHTENING TORQUES

Ottone / Brass		Acciaio zincato Zinc plated steel		AISI 316 / S.s. 316	
Filetto Thread	Coppia di serraggio* Recommended tightening torque Nm	Filetto Thread	Coppia di serraggio* Recommended tightening torque Nm	Filetto Thread	Coppia di serraggio* Recommended tightening torque Nm
R18	17	R18	22	R18	24
18K	17	18K	22	18K	24
18NPT	17	18NPT	22	18NPT	24
5/8UNF	30	5/8UNF	40	5/8UNF	45
R12	40	R12	55	R12	60
R14	25	R14	35	R14	40
14K	25	14K	35	14K	40
14NPT	25	14NPT	35	14NPT	40
M10	18	M10	25	M10	30
M12	23	M12	32	M12	35
10K	18	10K	25	10K	30
34K	50	34K	70	34K	80

TIPOLOGIA DI CONTATTI ELETTRICI UTILIZZATI / ELECTRICAL CONTACTS APPLIED













Contatti / Contacts			Normativa DIN-EN-60947-5-1 Standard DIN-EN-60947-5-1	Simbolo IEC 60617 Symbol IEC 60617
NA	NA normalmente aperto NO normally open	SPST (single pole, single throw)	X	
NC	NC normalmente chiuso NC normally closed	SPST (single pole, single throw)	Y	
SC	SC contatti in scambio CO change over (snap action)	SPDT (single pole, double throw)	C	

* Una scorretta coppia di serraggio può influenzare la durata della macchina del pressostato. Variando tipologia di materiale utilizzato per realizzare il corpo del pressostato, varierà anche la coppia di serraggio.

* Improper torque may affect the mechanical life of the switch. The relevant legislation has been expressed in various ways. By varying the type of material used to make the switch body, will also vary the tightening torque.

PRESSOSTATI / PRESSURE SWITCHES

PROTEZIONI ELETTRICHE ELECTRIC PROTECTIONS

Pagina / Page		PMN	PMM	PM250	PMB	MS	PS	PSM PSP	PMC PMC...D	PPC PPCF	PPC...D PPCF...D	PML	PPL	PSK	MPS	PHP	PHC		
Protezione IP 54 <i>IP 54 electric protection</i>		9	11	13	15	17	17	19...26	27	29	29	31	31	33	35	37	39		
Protezione IP 54 <i>IP 54 electric protection</i> CAP. 1  CAP. 10  CAP. 12  CAP. 16  CAP. 30  CAP. 31 		●	●	●	●												●		
		●	●															●	
									●										
							●	●								●			
																			●
																			●
Protezione IP 65 <i>IP 65 electric protection</i> CAP. 3  CAP. 13  Connettore DIN 43650 A <i>DIN 43650 A connector</i> 		●	●	●														●	
						●	●												
									●	●	●	●	●	●	●	●	●	●	
Protezione IP 67 <i>IP 67 electric protection</i> CAP. 14 + cavi + connettore <i>CAP. 14 + flying leads + connector</i>  Connettore M12 / M12 connector  Deutsch DT04-2P integrato 		●		●		●	●											●	
						●	●	●	●	●	●	●	●	●	●	●	●	●	
																	●		
DATI ELETTRICI <i>ELECTRIC DATA</i>		PMN	PMM	PM250	PMB	MS	PS	PSM PSP	PMC PMC...D	PPC PPCF	PPC...D PPCF...D	PML	PPL	PSK	MPS	PHP	PHC		
Tensione di alimentazione / Power supply	12 Vca/cc	●	●	●	●	●	●	●	●	●	●	●	●	●	●	●	●	●	
	24 Vca/cc	●	●	●	●	●	●	●	●	●	●	●	●	●	●	●	●	●	
	48 Vca/cc	●	●	●	●	●	●	●	●	●	●	●	●	●	●	●	●	●	
	110 Vca/cc			●		●	●	●	●	●	●	●	●	●	●	●	●	●	
	220 Vca/cc			●		●	●	●	●	●	●	●	●	●	●	●	●	●	
	250 Vca/cc			●		●	●	●	●	●	●	●	●	●	●	●	●	●	
Corrente massima / Max. current	< 30 mA	●	●	●		●	●	●	●	●	●	●	●	●	●	●	●	●	
	0.5 A	●	●	●	●													●	
	3 A								●	●	●	●	●	●					
	4 A																	●	
	6 A					●	●	●											
	7 A															●			
	8 A																	●	
	10 A								●	●	●	●	●	●	●				
15 A																		●	
Contatti argentati / Silver plated contacts		●	●	●	●	●	●	●	●	●	●	●	●	●	●	●	●	●	
Contatti dorati / Gold plated contacts		●	●	●	●	●	●	●	●	●	●	●	●	●	●	●	●	●	
Isteresi fissa / Fixed hysteresis		●	●	●	●	●	●	●	●	●	●	●	●	●	●	●	●	●	
Isteresi regolabile / Adjustable hysteresis								●											
Corpo Ch 24 / Body 24 AF		●	●	●	●	●	●					●	●		●	●			
Corpo Ch 27 / Body 27 AF								●											

Elettrotec si riserva la facoltà di apportare modifiche tecniche ai prodotti o di cessarne la produzione senza obbligo di preavviso. Il contatto del pressostato può danneggiarsi quando sottoposto a forti urti o ad alte vibrazioni. È responsabilità dell'utilizzatore verificare l'idoneità dei nostri prodotti per ogni particolare applicazione (ad esempio, la verifica della compatibilità dei materiali) e l'uso può essere appropriato solo se dimostrato in test sul campo. Le informazioni tecniche in questo catalogo si basano su prove effettuate durante lo sviluppo del prodotto e in base ai valori empiricamente raccolti. Essi non possono essere applicabili in tutti i casi.

Elettrotec reserves the right to technical data of change to the products or halt production without prior notice. The pressure switch contacts can be damaged when subject to strong shocks or high vibration. It is the responsibility of the user to test the suitability of our products for the particular application, for example, the verification of material compatibility. The use may only be appropriate if proven in field tests. The technical information in this catalogue are based on tests made during product development and based on empirically gathered values. They may not be applicable in all cases.