

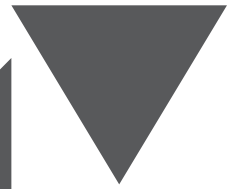

# GRAM



SERIE

**RH**

110 / 210

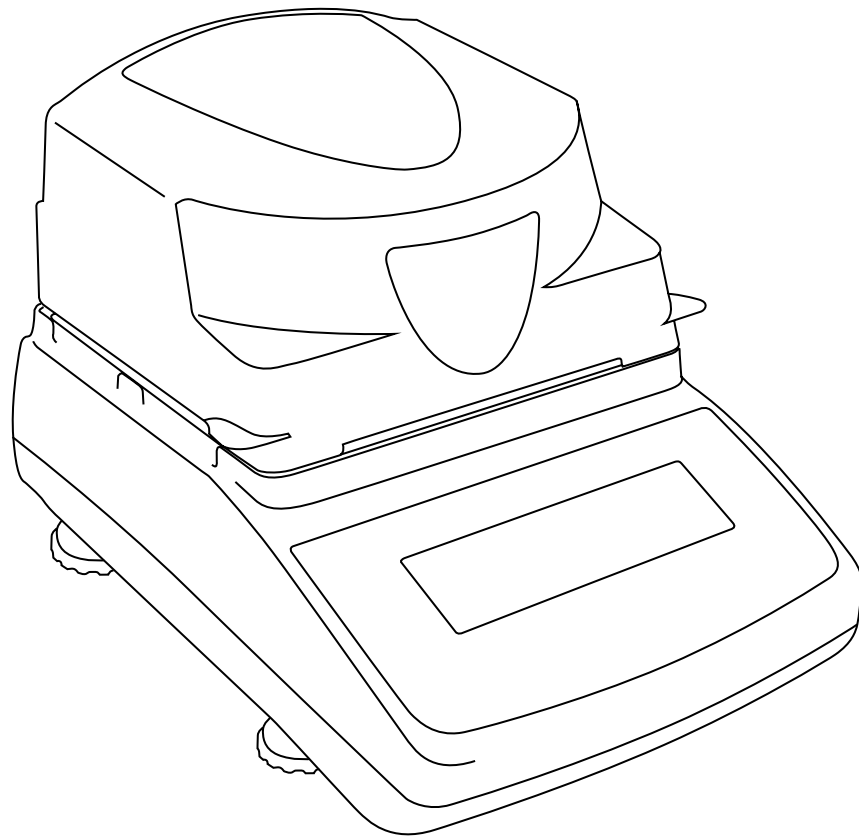

**OPERATION MANUAL**



## Content:

1.	Security rules	3
2.	Set	3
3.	Navigation – fast start	4
4.	Moisture analyzer menu diagram	6
5.	General description	7
6.	Technical data	7
7.	Keys and indicators	8
8.	Preparation to work	9
9.	Interfaces	12
10.	General working rules	12
11.	Description of thermogravimetric analysis	12
11.1	Infrared radiation source	13
11.2	Infrared radiation drying description	13
11.3	Drawing and preparation of a sample	13
11.4	Tools requirements	14
11.5	Single-use pans	14
11.6	Placing a sample	14
11.7	Glass fibre filter	15
11.8	Selection of drying parameters to the sample material	15
11.9	Other practical notes	16
12.	Moisture analyzer start	17
13.	Drying parameters settings	18
13.1	Setting drying temperature	19
13.2	Calculation methods	19
13.3	Drier working modes, drying time, sample time	20
13.4	Drying profiles	22
13.5	Moisture analyzer memory	22
13.5.1	Saving settings	23
13.5.2	Loading saved settings	24
13.6	Initial moisture analysis	25
14.	Proper moisture	27
15.	Connecting to a printer or computer – drying report	28
16.	Moisture analyzer options	30
17.	Testing and calibration	33
18.	Moisture analyser as a balance	34
18.1	Units	34
18.2	Auto-zeroing	35
18.3	Calibration	36
19.	Maintenance and repairs of small defects	38
	Declaration of Conformity	40
	Appendix	41

## 1. Security rules

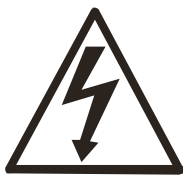

To avoid electrical shock or damage of the moisture analyzer or connected peripheral devices, it is necessary to follow the security rules below.

- To feed the analyser use only mains socket with ground contact.
- **Fuse is situated under the analyzer cover.**
- During heating, the halogen heaters warm up to very high temperature. Avoid touching the heaters as it may cause severe burns!
- Dryer chamber cover heats up to 60°C, but perforated cover at the top may heat up over 100°C. Do not touch the cover top during drying as it may cause severe burns.
- All repairs and necessary regulations can be made by authorised personnel only.
- Do not use the analyser when its cover is opened.
- Do not use the analyser in explosive conditions.
- Do not use the analyser in high humidity.
- If the device seems not to operate properly, plug it out of the mains and do not use it until checked by authorised service.
- Please return wasted device to the point of purchase or other company specialised in recycling of wasted electronic components.



According to legal regulations it is forbidden to dispose wasted electronic equipment in waste containers.

## 2. Set

The full set consists of:

1. Moisture analyzer,
2. Pan shield, pan support, pan handle,
3. Single-use pans – 10 pcs.,
4. Power supply cord,
5. User manual and guarantee card

Option on demand:

6. PT-105 thermometer with GT-105sk-8 probe
7. Distance sleeves 20mm – 2 pieces

### 3. Navigation – fast start

After turning on the moisture analyzer, after autotests and tare, moisture analyzer starts initial heating until the drying chamber heats up to 105°C. The moisture analyzer is now ready to measure density with inscribed earlier heating parameters.

To set heating parameters use *USER MENU* and choose *Drying settings*.

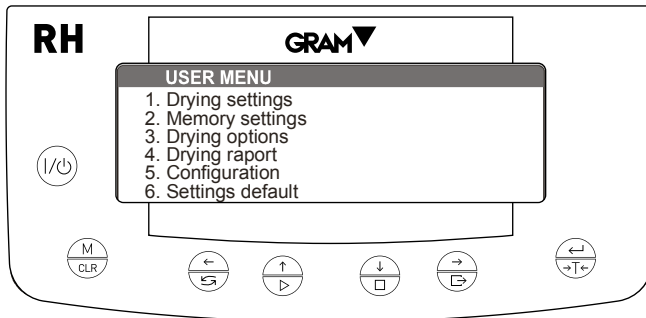

To move cursor between menu positions use ↑ and ↓ key.

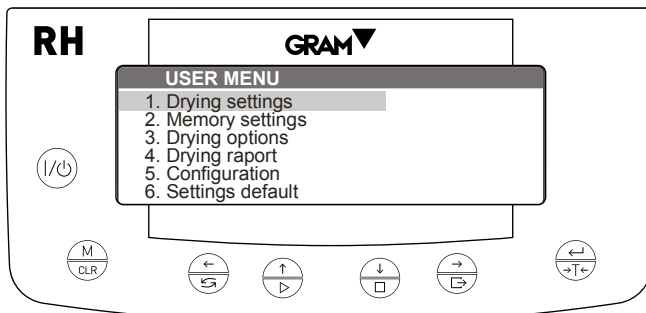

Entering chosen menu position is made by using → or ENTER key.  
Return ←.

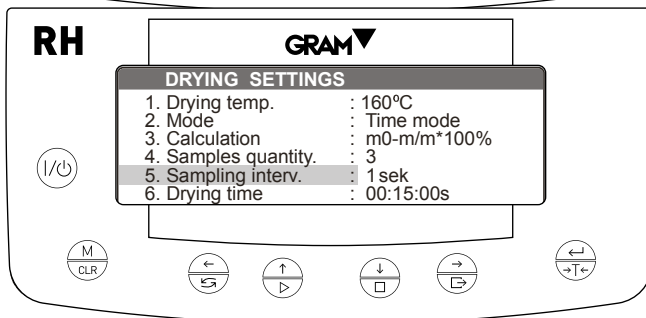

Entrance to parameters is made after choosing → or ENTER key.

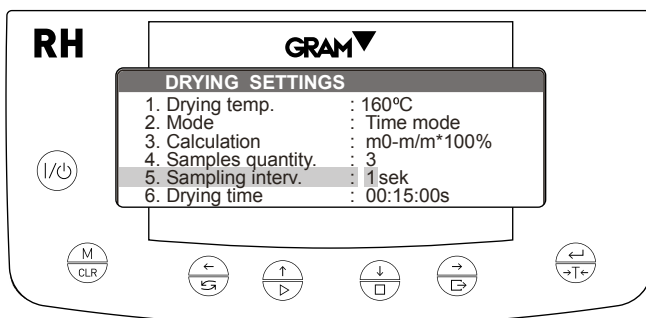

Parameter value modification is made by using ↑ and ↓ key, moving to another digit by → key.  
Confirmation using ENTER key.

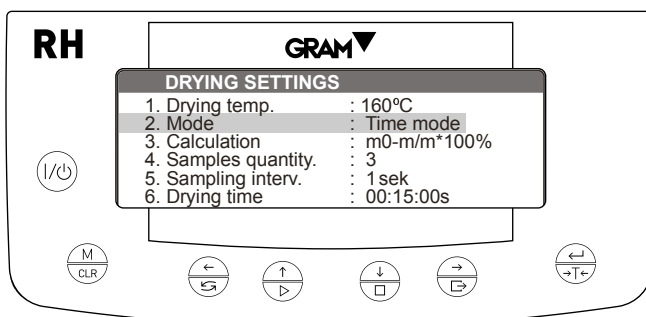

Selection of one of the available parameter options is made by → and ← key.  
Confirmation using ENTER.

Moisture analyzer can work in one of two modes, changed by ↻ key:

1) Drying (density measurement)

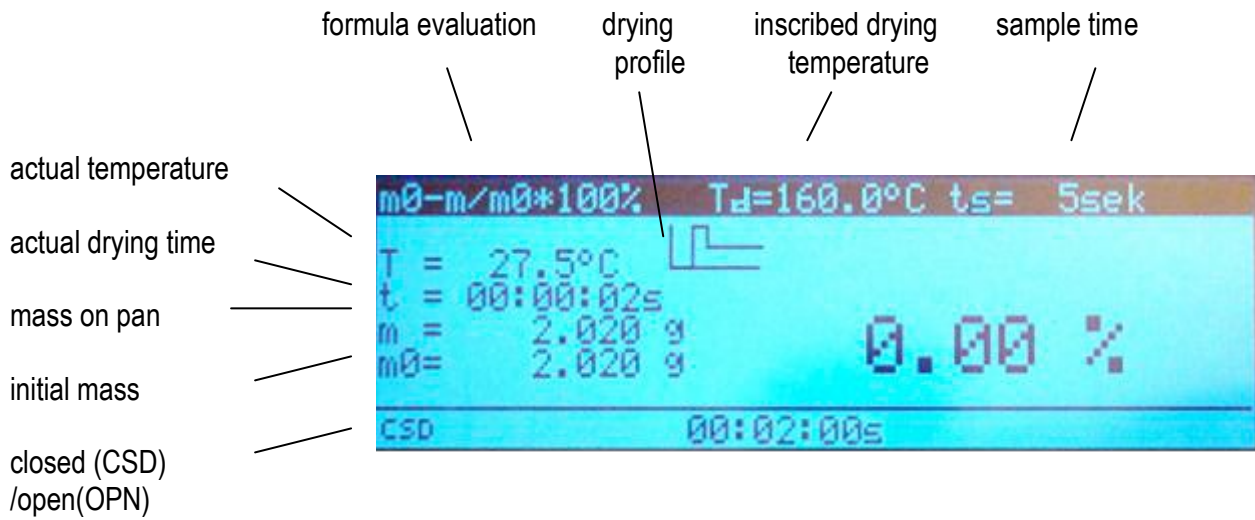

2) Weighing (mass measurement)

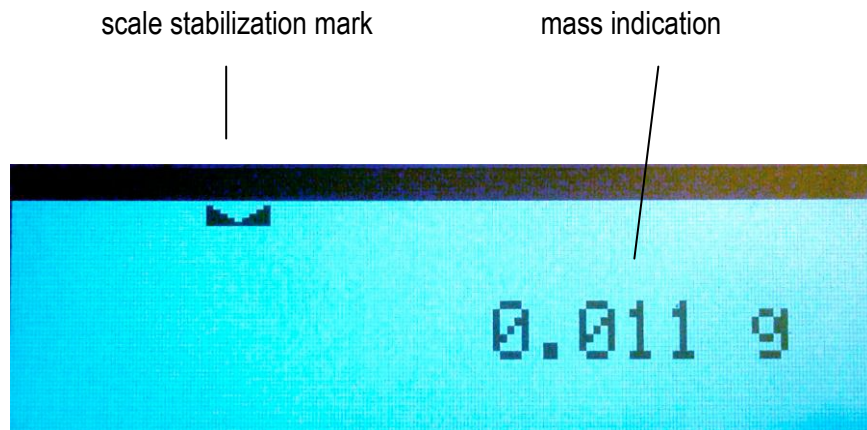

## 4. Moisture analyzer menu diagram

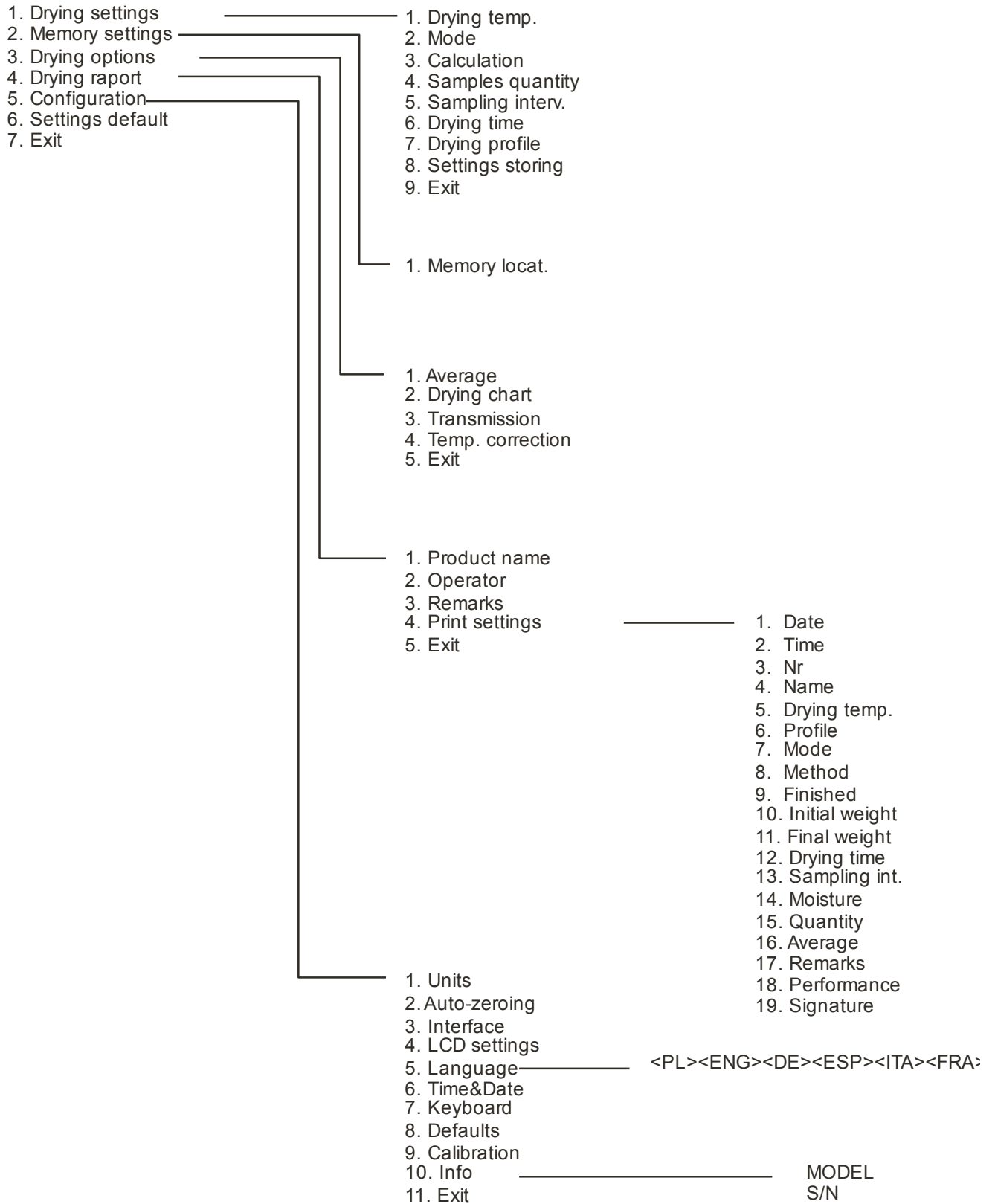

MODEL  
S/N  
SOFT  
AXIS Sp. z o.o.

## 5. General description

Moisture analyzers **GRAM - RS** are designed for fast and precise moisture determination of a sample based on mass loss during heating process.

Drying proces parameters are set by user on the basis of law norms, available chemical-physics data or they are matched experimentally. Parameters table for typical materials is contained in the A appendix.

Moisture analyzers are designed to work in food industry, construction materials industry, biotechnology, pharmacy, environment protection and others. Main field of use is quality control.

## 6. Technical data

Technical data	moisture analyzers	
Model	<b>RH-110</b>	<b>RH-210</b>
Range (Max)	110 g	210 g
Balance reading plot (d)	1mg	1mg
Minimal sample weight	20mg	
Work temperature	+18 + +33°C	
Density readout precision	1% (sample 0,02+0,5g) 0,1% (sample 0,5+5g) 0,01% (sample >5g)	
Humidity measurement repeatability	±0,1% (sample 2g) ±0,04% (sample 5g)	
Settings memory	20 drying programs (for 20 different materials)	
Maximal drying temperature	160°C	
Sample time	1 + 180s	
Maximal drying time	10h	
Drying mode	time, short (automatic), manual	
Halogen radiators	2 x 100W 78mm	
Drying chamber heating time up to 100°C	<75s	
Pan dimensions	φ90mm	
Drying chamber dimensions	φ108 x 20mm	
Connections	RS232C (for computer and printer), USB (for computer), PS2 (for computer keyboard)	
Supply	~230V 50Hz 230VA	
Dimensions	185 x 290 x 170mm	
Weight	3,9kg	
Recommended calibration weight (OIML)	F2 100g	F2 200g

Supply protection: fuse WTA-T 3,15A 250V

## 7. Keys and indicators

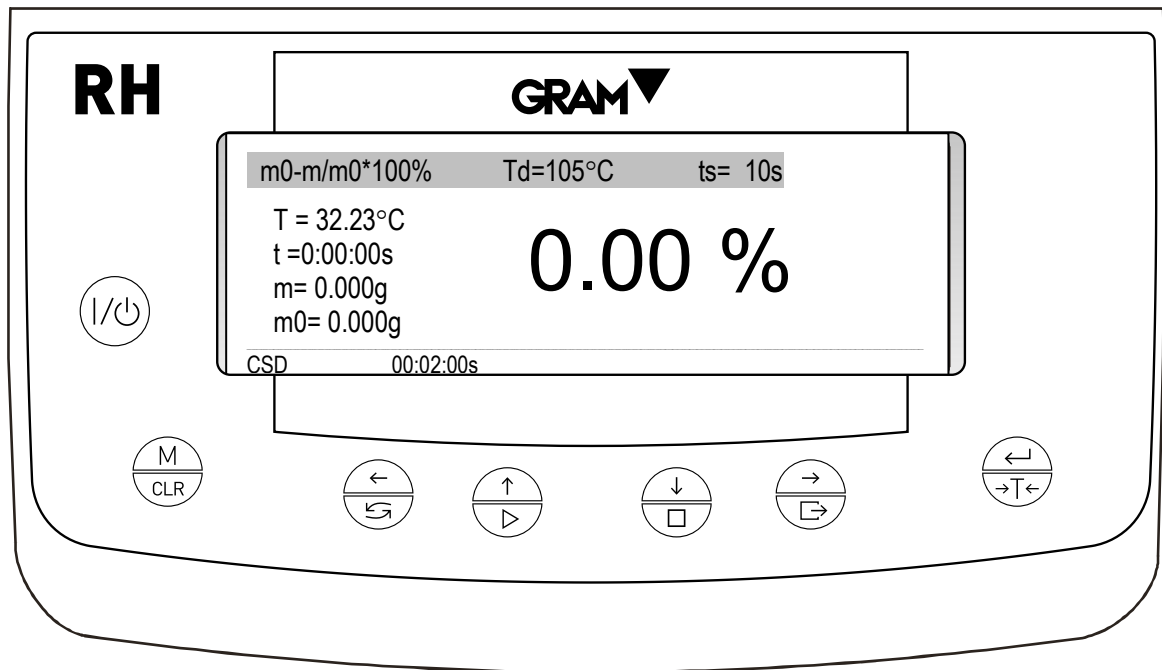

**I/O** - on / off (standby),

**MENU** - enter to menu,  
**CLR** - deleting operation,

- switching modes drying/ weighing,  
 - navigation key,

**START** - measurement start (drying),  
 - navigation key,

**STOP** - natychmiastowe zakończenie suszenia,  
 - navigation key,

- printout (transmission) of the result,  
 - navigation key,

**ENTER** - confirmation / option choice,  
 - tare (zeroing) scale,

Indicators:

- signalling stabilization of measurement result,  
**CSD/OPEN** - signaling closed/open drying chamber



## 8. Preparation to work



During heating, the halogen heaters **1** warm up to very high temperature. When drying chamber is opened avoid touching the heaters as it may cause severe burns or damage the heaters!

Dryer chamber cover **3** heats up to 60°C, but perforated cover may heat up over 100°C. Do not touch the top cover during drying as it may cause severe burns!

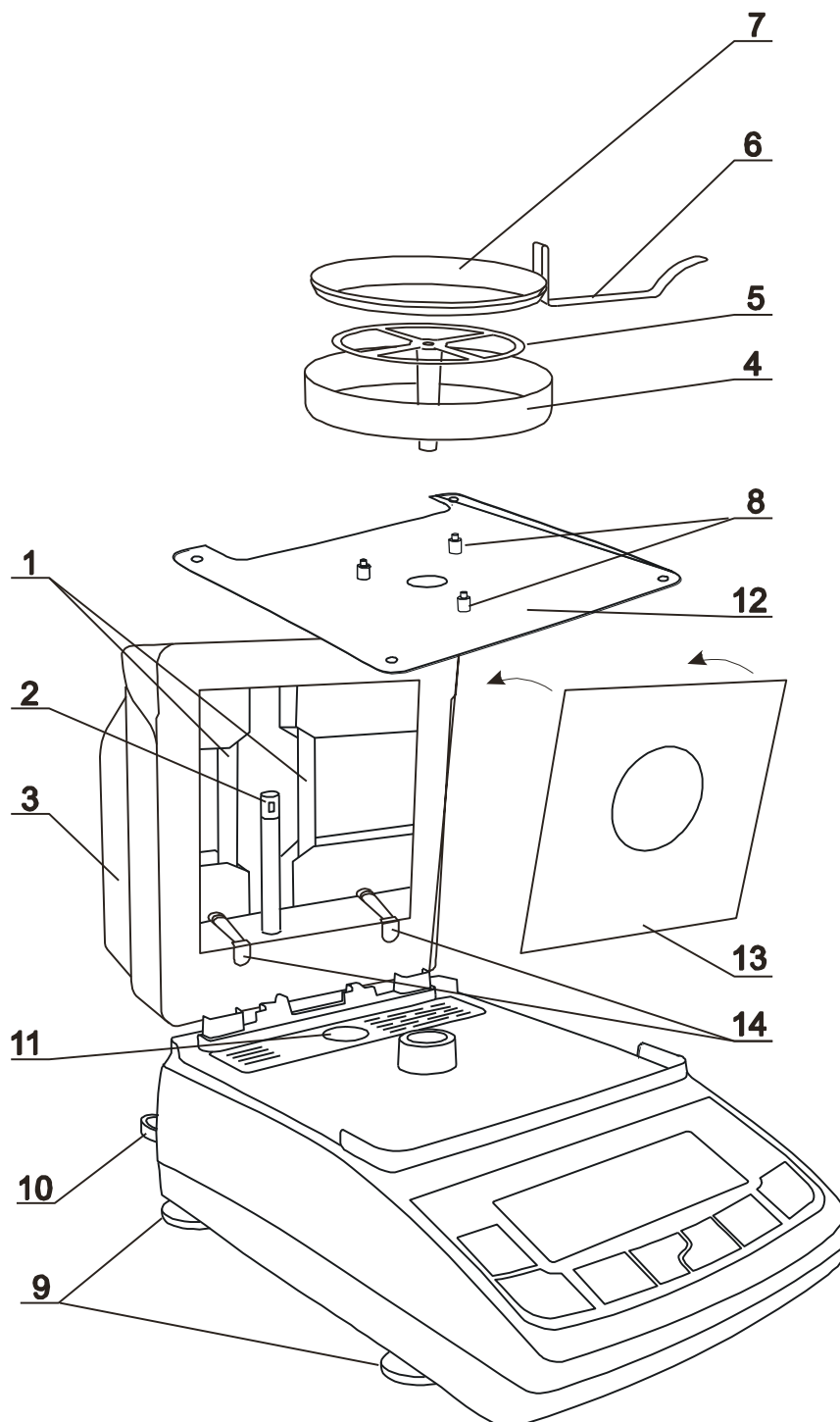

1. Take all contents out of a package: the moisture analyser and packed separately: the tin pan shield, single use pans, the pan handle and the pan support. It is recommended to keep the original scale package in order to transport the moisture analyzer safely in future.
2. Place the moisture analyzer on a stable ground not affected by mechanical vibrations and airflows.
3. Level the moisture analyzer with rotating legs 9 so that the air bubble in water-level 10 at the back of the moisture analyzer is in the middle and the moisture analyzer rests on all four legs.
4. Open the drying chamber 3 by lifting it by a grip at the front. Insert the window 13 into chamber cover, edges of the window should be located in the latch grooves 14 (push the window until You hear a “click” from all four latches).
5. Put drying chamber floor board 12 on four position pegs in moisture analyzer cover. Put covering plate 4 on three distance pegs 8. Put carefully pan mandrel 5 into scale mechanism hole.
6. Put on empty single-use pan 7 on grip 6 and using the grip place the single pan on scale’s carrying pan (grip ring 6 will be located inside the plate but due to longer diameter it will not rest on carrying pan 5).
7. Close the moisture analyzer chamber 3 and connect the scale to 230V supply.
8. This will start moisture analyzer autotests and after stabilization zero indication will show up. Moisture analyzer will start initial heating signalled by a proper communicate on the screen. After initial heating moisture analyzer is ready to work.

Removing the glass (to clean or remove radiators):

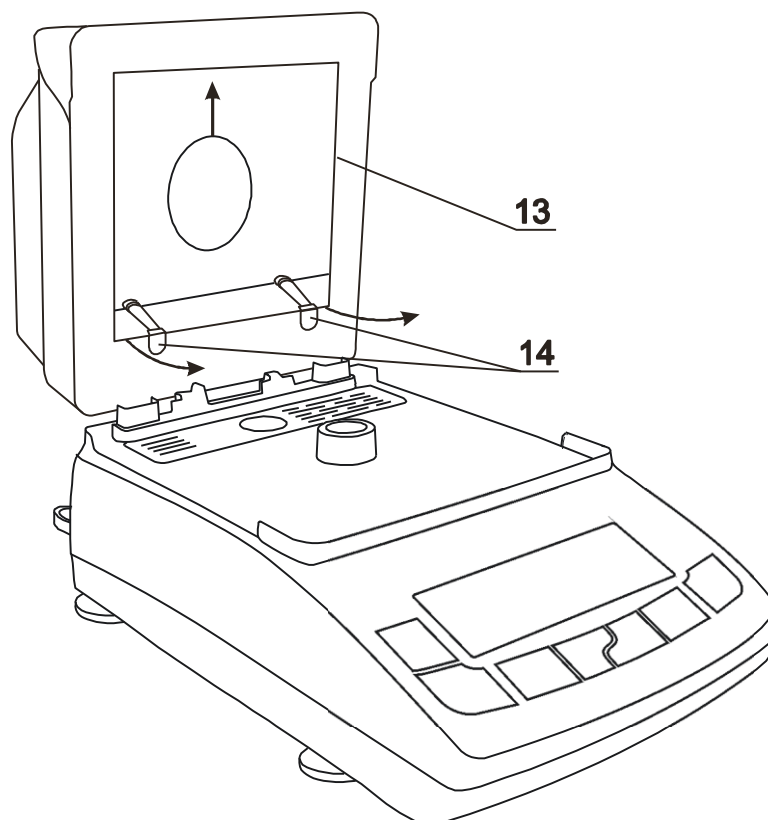

1. Open the moisture analyzer chamber.
2. Raise glass 13 until it will be released from lower glass supports 14.
3. Remove the glass by diverting lower limb (look at the picture above).



When temperature during initial heating exceeds 105°C or heating time is longer than 3 minute, terminate initial heating with STOP key and check if the temperature sensor 2 works properly and if both halogen heaters light 1 (see chapter 15).

In case any defect occurs contact an authorised service point.

4. Moisture analyzer shouldn't be used to weigh ferromagnetic materials due to deterioration of measurement precision.



The fuse 11 is available after cover opening and putting out floor board 12. During damaged fuse exchange use a fuse with parameters presented in technical data (ch. 6). Using other fuse may cause electrical shock.

## 9. Interfaces

The moisture analyser is equipped with RS232C interface to connect a printer or a computer and with PS2 port to connect an external computer keyboard.

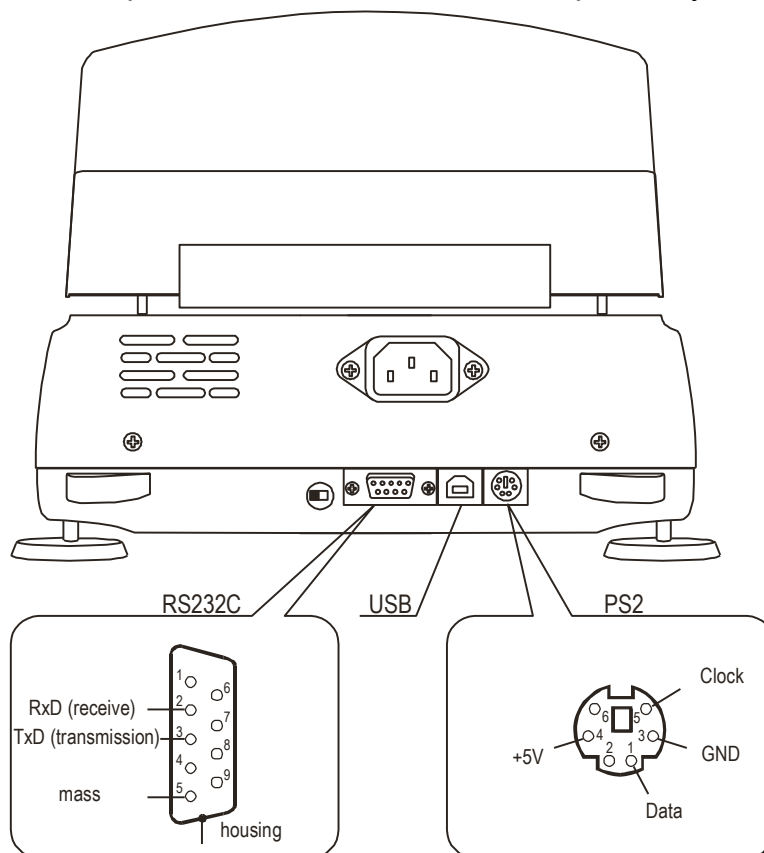

## 10. General working rules



***During transportation remove the pan, the pan support and the pan shield and place it in a separate package..***

1. Distribute a sample all over the pan. A sample surface should not touch temperature sensor placed above the pan.
2. The balance is equipped with the tare equal to its range. To tare the balance press  $\rightarrow T \leftarrow$  key. Writing the tare does not extend measuring range, but only subtracts the tare value from a load placed on the pan. To make weight control easier and to avoid range overdrawing, the balance is equipped with weight indicator (graduated in percentages).
3. Do not overload the moisture analyzer more than 20% of maximum load (*Max*).
4. The mechanism of the moisture analyzer is a precise device sensitive to mechanical strokes and shocks. Do not press the pan with a hand.

## 11. Description of thermogravimetric analysis

This section gives some practical details about moisture analysis using infrared radiation for reliable results and easier use of moisture analyser. The description is based on a pre-production experience and customers' suggestions.

Moisture in substances is an essential quality factor of technical and economical importance.

Methods of determining moisture may be grouped in two main categories: absolute and deductive.

Absolute methods are based on simple relations, e.g. weight decline during drying. Thermogravimetric analysis used in AXIS moisture analyser is an example of this method.

Deductive (indirect) methods measure physical quantity related with moisture, e.g. electromagnetic waves absorption, electrical conductance, acoustic wave speed. Some of these methods, unlike thermogravimetric analysis, enable to determine water content.

**Thermogravimetry** - *lat.* thermo – heat, gravi – weight, metry – method

**Thermogravimetric analysis** – a process of determination of a substance mass decline as a result of heat-up. The sample is weighed before and after heating-up, the difference is calculated in relation to initial weight or final weight (dry mass).

### **Moisture in substances**

Thermogravimetric analysis includes all ingredients evaporating from substances during heating-up, which results in weight decrease.

In result of the above, determining of moisture content in substances is not equal water content. Beside water, moisture consists of all other volatile matter: fats, alcohol, aromas, organic dissolvent and other substances resultant as an effect of thermal decomposition.

Thermogravimetric analysis does not distinguish water from other volatile matters.

Infrared radiation drying is more effective than traditional methods (e.g. in an oven) as the radiation deeply penetrates the substance, which shortens drying time.

#### **11.1 Infrared radiation source**

**GRAM - RS** series moisture analyser uses 2 halogen heaters (rated power 100W, l=78mm) in serial connection as a radiation source. The heaters emit also visible radiation, which does not affect drying process.

#### **11.2 Infrared radiation drying description**

Sample drying is a result of absorption of infrared radiation, which results in sample temperature increase and evaporation of volatile matters.

Infrared radiation penetrates surface layers, the depth depends on penetrability of a sample (different in various substances). Part of radiation is reflected by the sample surface. Penetrated layers absorb the radiation and convert its energy into heat. Emitted heat propagates inside the sample. Effectiveness of the propagation depends on thermal conductivity of the sample. The better the conductivity, the faster drying process and volatile matter evaporation. During drying process sample parameters change, its thermal conductivity decreases so there is a risk of burning the sample. Some parameters may be estimated “by sight”, e.g. smooth and light surfaces reflect radiation better. This must be taken into account when setting drying parameters.

#### **11.3 Drawing and preparation of a sample**

As sample of given substance must be representative, drawing and preparing a sample is very important process as it affects repeatability of measurements. The most common

method of homogenizing a sample is mixing. The other method is to draw few samples from different but specific points in a substance and calculate an average value. Another – to draw few samples from different points in a substance, mix them and draw a sample from the mixed samples.

Sampling method depends on the object of a research. For quality purpose many representative samples are analysed. In production control it is enough to assure sampling repeatability, which enables to study a tendency.

While preparing and drawing, it is important that the sample does not absorb moisture from the environment – it is advised that operation time is as short as possible.

If it is necessary to analyse more than one sample at the same time, the samples should be closed in plastic bags or other isolated containers. Give attention that samples must not lose moisture inside the container (the container should not consist of too much air, the moisture condensed on the sides of the container should be mixed with the sample again).

#### **11.4 Tools requirements**

Tools and instruments used in preparation process may affect measurement accuracy, so it is advised not to use tools that transmit heat, as it makes the sample lose moisture before analysis.

Use only special mills and pestles.

In case of liquids with consisting of solid materials use a glass mixer, a spoon or a magnetic mixer.

#### **11.5 Single-use pans**

To analyse the moisture, put a sample on a single-use pan and place it in the dryer chamber.

Using non-reusable pan helps to avoid false results by remains of previous samples.

10 single use pans are provided with the moisture analyser. Any quantity may be delivered on demand.

#### **11.6 Placing a sample**

A sample should be placed uniformly all over the pan, so that heat propagates equally all over the sample and dries whole sample effectively and quickly without leaving “wet” places.

**Correct**

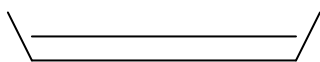

**Incorrect**

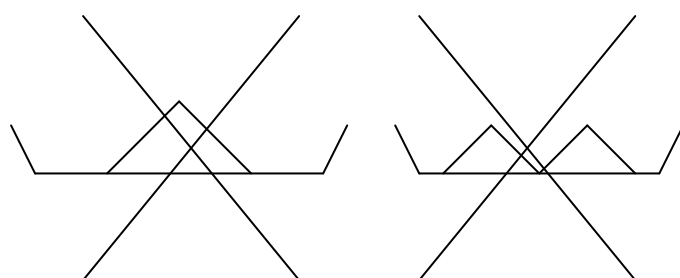

**Attention:**

Due to temperature sensor localisation, max sample height is 10mm.

When substance ply is too thick, surface layers will be heated too much and internal – not enough. This may result in burning the sample or surface incrustation, which will make drying process difficult and measuring result false.

A sample should be placed in uniformed layers 1÷3mm thick, weighing 1÷10g, depending on a substance.

**11.7 Glass fibre filter**

When drying liquids, pastes or substances that may melt or loose liquid during drying, it is advised to use glass fibre filters.

Filters ensure equal liquid distribution or, in case solid materials, avoiding burning a sample.

**11.8 Selection of drying parameters to the sample material**

Selection of proper temperature and drying time is essential to achieve precise humidity measurement. Drying parameters are selected properly if repeatability is on satisfactory level, usually between 0,1÷1%.

Parameters choice should be made in 3 steps:

**Step 1:** Drying temperature is related to the physico-chemical properties of the sample. It is determined by the number of tests carried out in several successive temperatures, e.g., at intervals of 10 ° C. Proper temperature is the highest value for which the sample for a few minutes does not change color and smell. Changing the color or odor indicates the start of the oxidation of the sample, which changes the properties of the sample, which usually affects the measurement accuracy.

**Step 2:** Weight of sample used should be large enough to use the entire surface of the pan, however, the thinner the layer of sample the better the drying process proceeds. The top and bottom layers of the material should be dried similarly at the same time. If the material is covered with shell and some moisture is trapped in the material, user should disintegrate the material or reduce the drying temperature. For liquid materials is preferable to use filter which accelerates the drying.

**Step 3:** Select drying time to chosen mass of sample. To do this, set the moisture analyzer's drying time as long as possible and observe the drying process. Minimum drying time is the one at which the sample doesn't change its weight by more than allowed by the examiner measurement error. Proper drying time is designated minimum drying time with reserve. The percentage value of the reserve must exceed the mass of the sample dispersion - the drying sample time is proportional to the mass of the sample.

After a few measurements with the designated drying parameters and making sure that the reproducibility of the results is satisfactory user can proceed to optimize the measurement time by selecting favorable *Drying profile* and using *Short* measurement mode. Of course you should check that the reproducibility of the results was not seriously affected.

Sample values for the most common materials are given in the Appendix, however, be regarded only as preliminary data and it is recommended to carry out the procedure for parameters selection for the test material.

### ***11.9 Other practical notes***

It is preferable to work with the same mass of the sample at each measurement to measure the size of the sample in a reproducible way. It is best to use the same instruments for the application of the sample.

Put a sample on the pan as quickly as possible to avoid losing moisture.

Temperature inside the chamber is much higher than outside, so the sample may evaporate partly before measurement begins, which will result in a false result.

When analysing the same substance quantity in successive measurements, use the same tools to put a sample to be sure that samples are each time of the same size.

Before putting a sample, tare a single-use pan and take it out of the chamber. Right after putting a sample on the pan, place it inside the analyser chamber, close the chamber and press START.

Be sure that no dirt sticks under the pan, as it may increase sample weight and result in false values.



## 12. Moisture analyzer start

After switching-on the moisture analyser proceeds with self-tests and displays company logo.

Next the moisture analyzer is taring (-----). After taring initial heating starts in order to create proper conditions inside drying chamber.

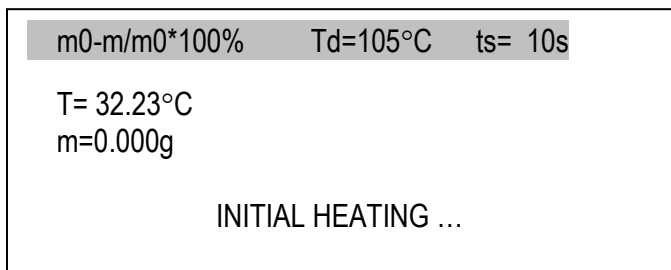

Initial heating should warm the drying chamber up to 105°C within 3 minute.

When temperature during initial heating exceeds 105°C or heating time is longer than 3 minute, terminate initial heating with STOP key and check if the analyser is not damaged (see chapter 15).

After initial heating is completed (or terminated), the device displays the following information:

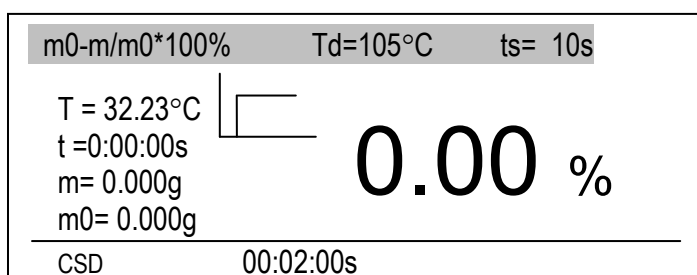

Legend:

$m_0 - m / m_0 * 100\%$  - formula used to calculate the moisture

$T_d$  – defined drying temperature

$t_s$  – defined sample drying time

T – current temperature in the drying chamber

m – current weight,

t – current drying time

$m_0$  – initial weight

 - Graphical marking of drying profile

CSD – closed cover indication

(centrally in lower line) – inscribed drying time

### **13. Drying parameters settings**

In order to achieve proper density measurement results following parameters should be set:

- *Drying temperature* (to 160°C),
- *Mode* : *time mode* (ends after inscribed time) or *short mode* (ends after fulfilling drying criterion),
- *Calculation method* – humidity calculation formula,
- *Samples quantity* (only for *short mode*),
- *Sampling interval* – interval between successive mass measurements (1÷180s.),
- *Drying time* (1s.÷10h) (in *short mode* it's the maximal drying time),
- *Drying profile* (*standard, slow, step* or *fast*),
- *Settings storing*– number of place in memory (1÷10), where the setting will be stored.

In case of choosing *short mode* additionally set:

- *Samples quantity* (2, 3, 4 or 5) – the decisive quantity concerning drying ending.

During setting parameters use navigation keys and *ENTER* key according to description in *Navigation*.

In order to save settings (also after turning off the scale from supply), use *Exit* option after making all changes.

### 13.1 Setting drying temperature

During setting drying temperature set successively values of individual digits.

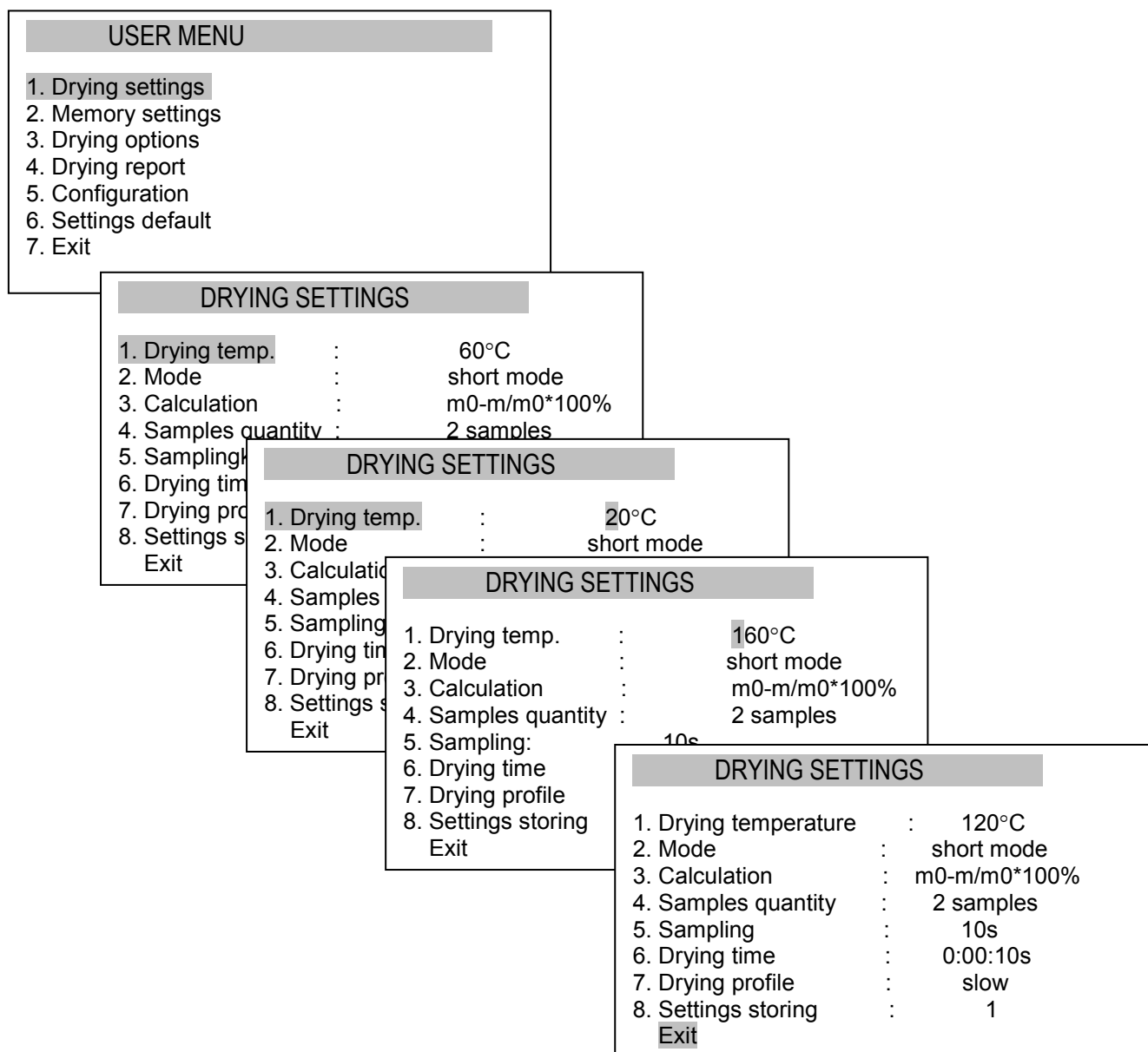

## 13.2 Calculation methods

Humidity may be calculated upon the basis of various mathematic formulas, defined in balance – drier as *Calculation method*:

1. Relative humidity, defined in relation to initial mass

$$w [\%] = m_0 - m / m_0 * 100\% ,$$

where  $m_0$  – initial mass,  $m$ - current mass

2. Relative humidity, defined in relation to current mass

$$w [\%] = m_0 - m / m * 100\% ,$$

3. Percent current mass content in sample

$$w [\%] = m / m_0 * 100\% .$$

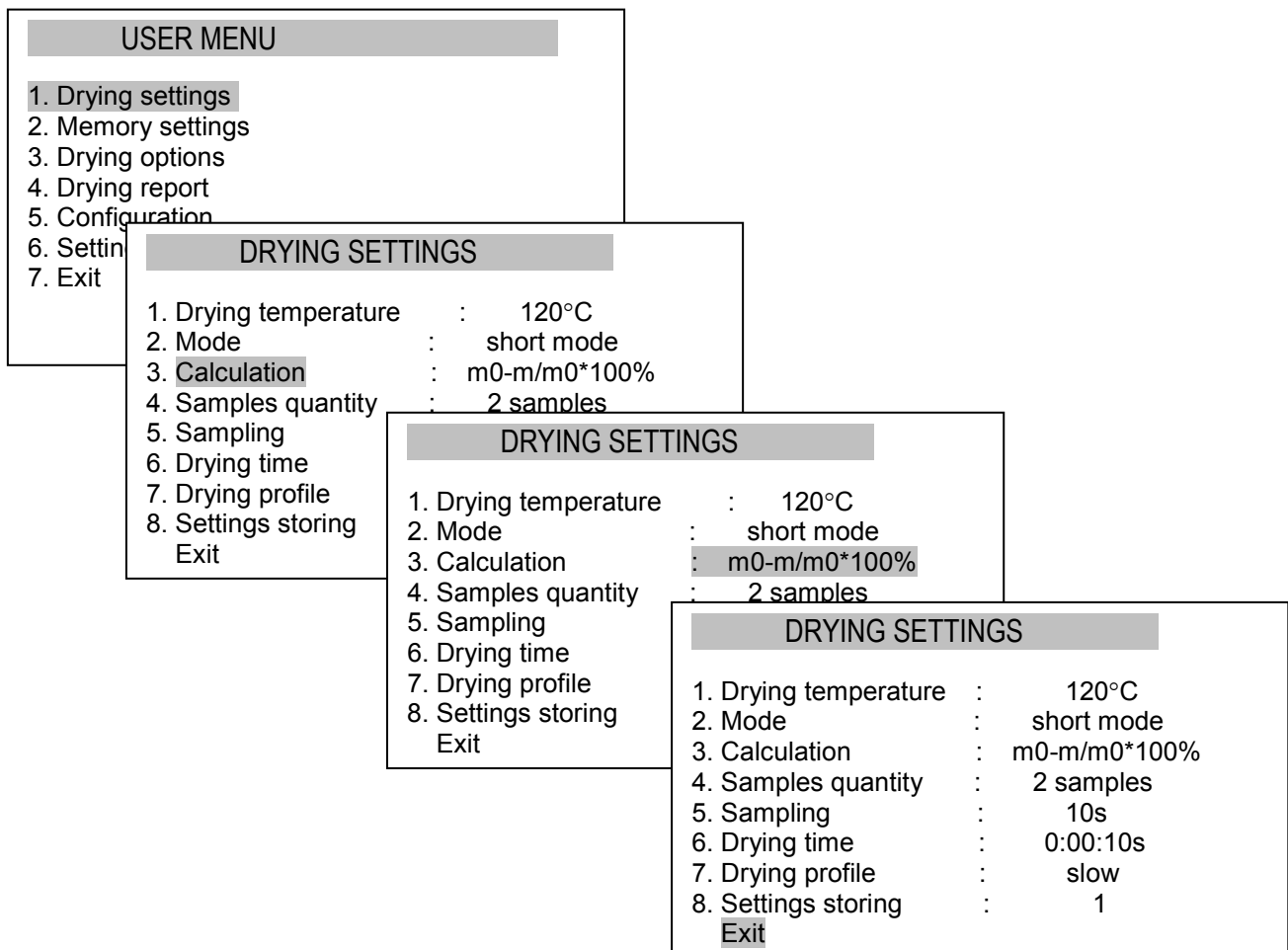

### 13.3 Drier working modes, drying time, sample time

During the balance – drier operation sampling of the mass on the pan takes place. Sampling time is set by the user, according to drying process speed. As a result of sampling the current humidity value is calculated and displayed. Measurement is finished depending on selected Drying mode:

1. In *Time mode* total humidity measurement time (Drying time) is defined by the user,
2. In *Short mode* humidity measurement is finished, when drying is stopped and differences of a few successive mass samples are smaller than threshold value (2 mg). Amount of successive samples taken into consideration is defined as *Samples quantity*. Measurement is finished when Drying time is exceeded at the latest.

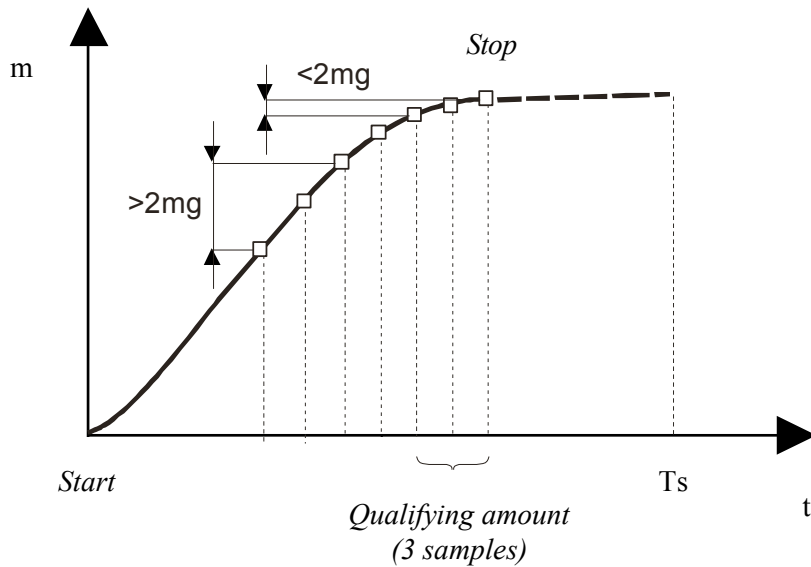

Drying chart in *Short mode* for *Samples quantity* = 3.

When choosing time mode only *drying time* and for example 10 times shorter *sample time* is needed to start. In *Short mode* additionally *Samples quantity* is needed and *Samples interval* should be carefully calculated – end of drying is based on this parameter (and on *Samples quantity*).

<b>USER MENU</b>																					
<ol style="list-style-type: none"> <li>1. Drying settings</li> <li>2. Memory settings</li> <li>3. Drying options</li> <li>4. Drying report</li> <li>5. Configuration</li> <li>6. Settings default</li> <li>7. Exit</li> </ol>	<table border="1" style="width: 100%; border-collapse: collapse;"> <tr> <td colspan="2" style="background-color: #cccccc; text-align: center; padding: 5px;"><b>DRYING SETTINGS</b></td> </tr> <tr> <td style="padding: 2px 5px;">1. Drying temperature</td> <td style="padding: 2px 5px;">: 120°C</td> </tr> <tr> <td style="padding: 2px 5px;">2. Mode</td> <td style="padding: 2px 5px;">: short mode</td> </tr> <tr> <td style="padding: 2px 5px;">3. Calculation</td> <td style="padding: 2px 5px;">: <math>m_0 - m / m_0 * 100\%</math></td> </tr> <tr> <td style="padding: 2px 5px;">4. Samples quantity</td> <td style="padding: 2px 5px;">: 2 samples</td> </tr> <tr> <td style="padding: 2px 5px;">5. Sampling</td> <td style="padding: 2px 5px;">: 10s</td> </tr> <tr> <td style="padding: 2px 5px;">6. Drying time</td> <td style="padding: 2px 5px;">: 0:00:10s</td> </tr> <tr> <td style="padding: 2px 5px;">7. Drying profile</td> <td style="padding: 2px 5px;">: slow</td> </tr> <tr> <td style="padding: 2px 5px;">8. Settings storing</td> <td style="padding: 2px 5px;">: 1</td> </tr> <tr> <td colspan="2" style="padding: 2px 5px;">Exit</td> </tr> </table>	<b>DRYING SETTINGS</b>		1. Drying temperature	: 120°C	2. Mode	: short mode	3. Calculation	: $m_0 - m / m_0 * 100\%$	4. Samples quantity	: 2 samples	5. Sampling	: 10s	6. Drying time	: 0:00:10s	7. Drying profile	: slow	8. Settings storing	: 1	Exit	
<b>DRYING SETTINGS</b>																					
1. Drying temperature	: 120°C																				
2. Mode	: short mode																				
3. Calculation	: $m_0 - m / m_0 * 100\%$																				
4. Samples quantity	: 2 samples																				
5. Sampling	: 10s																				
6. Drying time	: 0:00:10s																				
7. Drying profile	: slow																				
8. Settings storing	: 1																				
Exit																					

### 13.4 Drying profiles

*Drying profile* will be used to optimization of drying process by accommodation a process to physical properties of sample material. Oxidized materials or thickening on the surface need *slow* or *step* profile. Resistant materials can use *fast* profile . The choice of profile and his parameters should be a result of experience with examined material.

DRYING SETTINGS	
1. Drying temperature	: 120°C
2. Mode	: short mode
3. Calculation	: $m_0 - m / m_0 * 100\%$
4. Samples quantity	: 2 samples
5. Sampling	: 10s
6. Drying time	: 0:00:10s
7. Drying profile	: standard
8. Settings storing	: 1
Exit	

After choosing a profile set proper parameters for example t1 and T1.

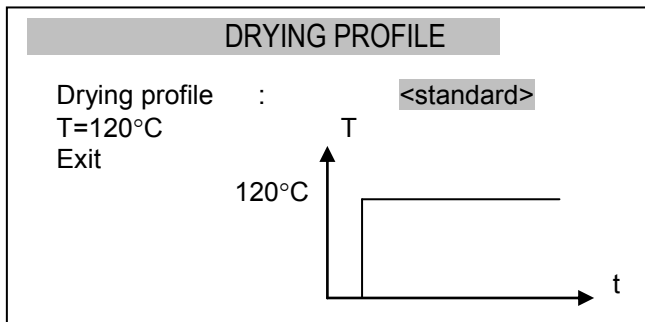

**Attention:** Final drying temperature is inscribed only in *Standard* profile or in *Drying setting* (main menu).

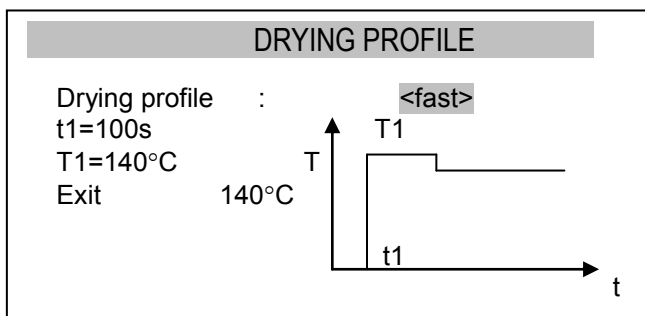
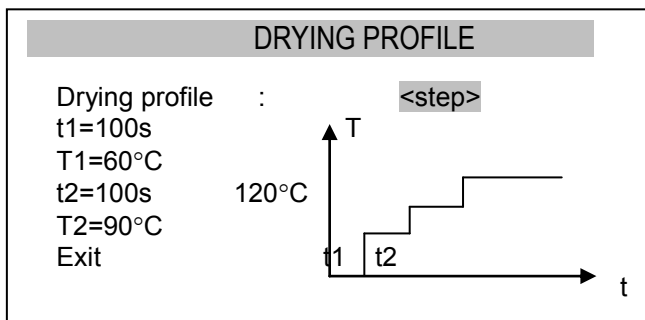
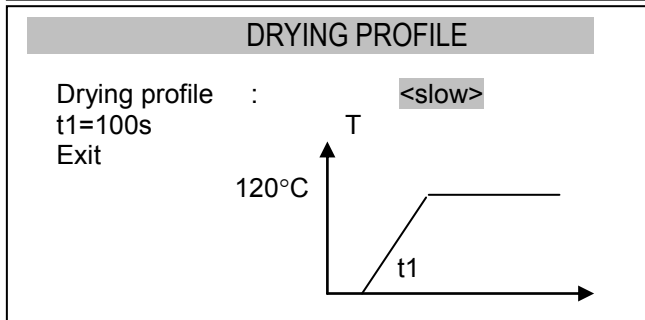

### 13.5 Moisture analyzer memory

The moisture analyser enables to save 20 different drying settings. Saved settings are kept in the memory even after unplugging moisture analyzer from the mains.

#### 13.5.1 Saving settings

In order to store a few settings follow the instructions below:

Set the necessary drying settings (as mentioned earlier), choose *Settings storing* and choose memory cell, where the sets will be saved.

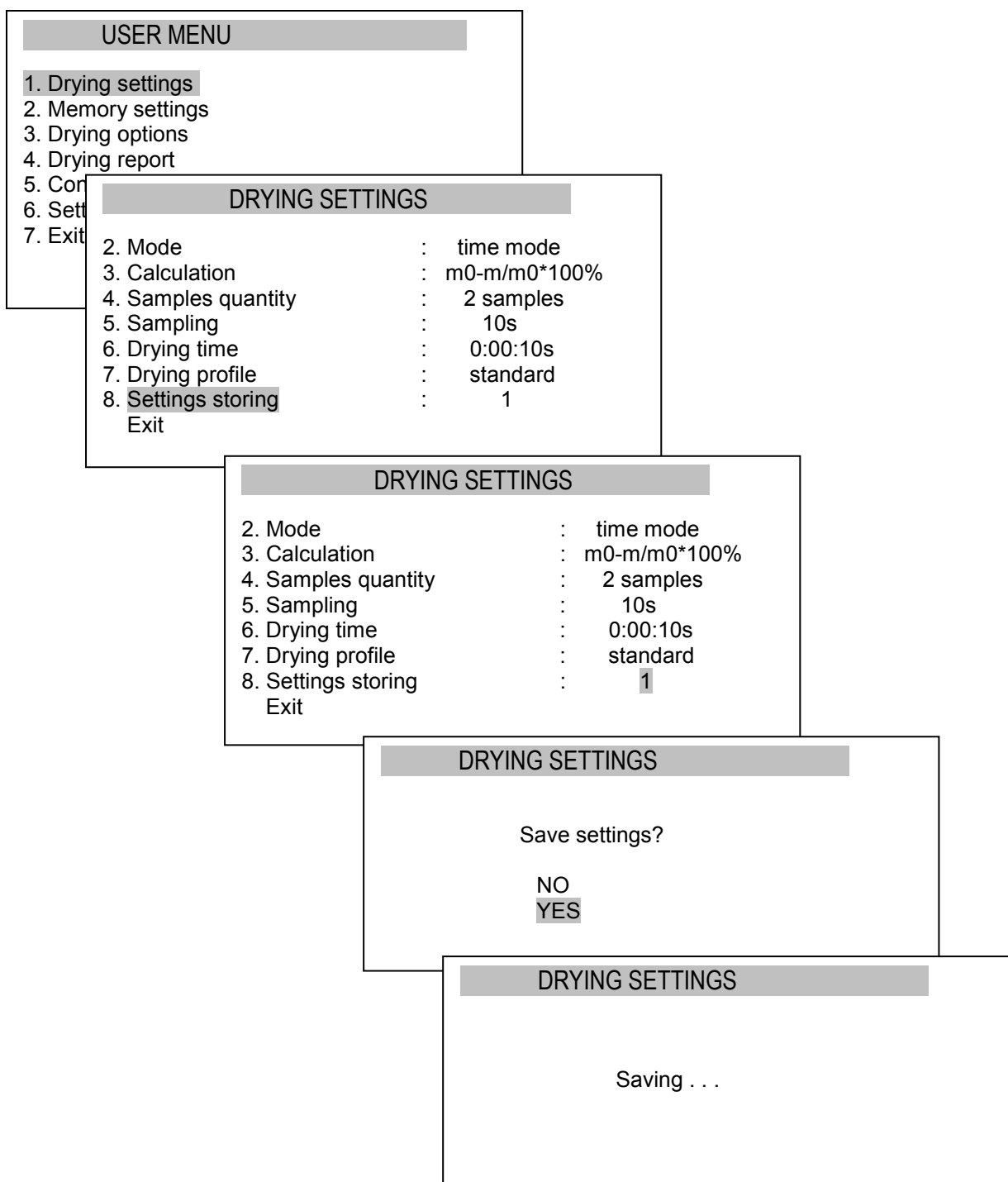

### 13.5.2 Loading saved settings

In order to call earlier settings saved in memory, You enter the menu and choose option *Memory settings* and choose memory cell number where settings were earlier made.

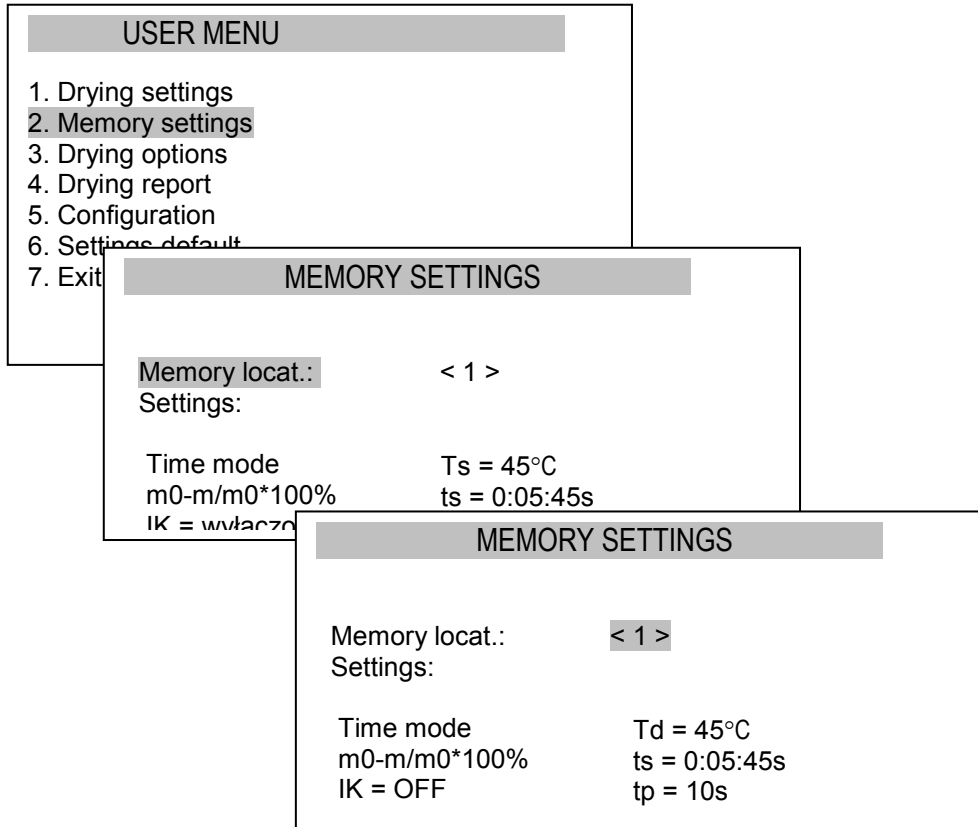



### 13.6 Initial moisture analysis

To determine optimal drying parameters for unknown sample, it is recommended to perform initial measurement with activated drying chart displaying. To do this, set the following drying parameters (see Drying parameters setting):

- Operation Mode: Time mode
- Calculation method:  $m_0 - m / m_0 * 100\%$
- Drying temperature:
  - organic substances: 80 - 120 °C
  - inorganic substances: 140 - 160 °C
- Samples quantity: do not set
- Sampling interval: 1 second
- Drying time: set time, after which the sample will be definitely dried

More information regarding temperature and drying time in *A appendix*.

To activate displaying of drying chart, which will be visible on the display instead of humidity indication, perform the following actions:

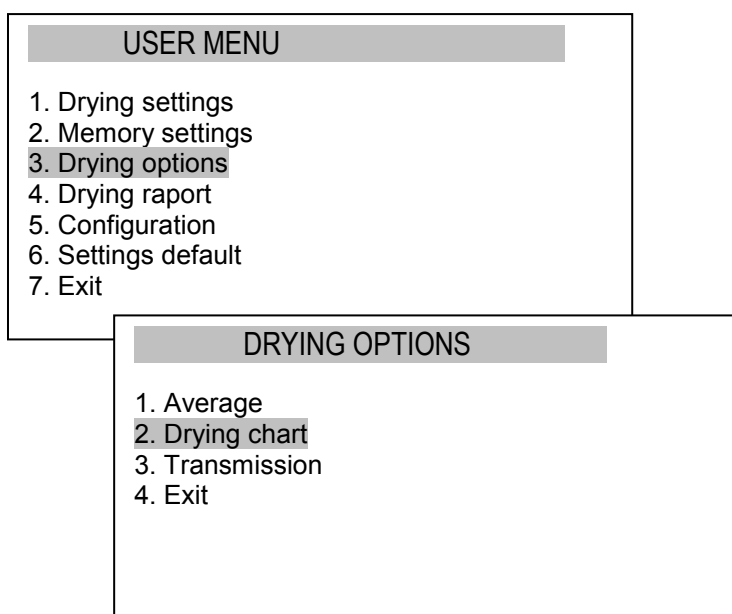

Tare the moisture analyzer with empty single-use pan (→T← key).

Put a sample of examined material on single-use pan, put it into drying chamber and press *START* key.

After measurement a drying graph will show up:

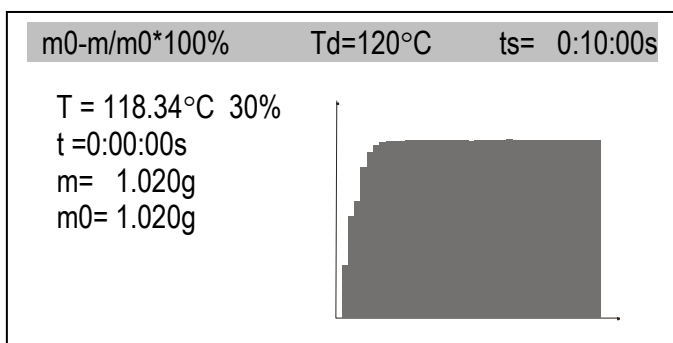

Observing drying process chart it is possible to evaluate its course and define time required for complete drying. The chart shows 160 time samples on the X axis (for longer times chart is scaled to 360 samples, 720, etc.) and humidity value according to selected formula on the Y axis (chart is automatically scaled to 10%, 30%, 50%, etc.). Selecting 1 s of sampling time allows for more precise chart.

Achieved chart allows for initial settings selection for main measurement. *Drying temperature* should be selected according to dries material type, so the drying is performed quickly and sample does not change colour. Material drying moment is visible on the chart as drying characteristic bending. As *Drying time* for main humidity measurement select time from the beginning to chart “flattening”. As the time axis is not described on the chart, use “evaluation with high margin”. Too short drying time does not allow to achieve precise humidity measurement results.

In case of *Short mode*, in main measurement select *Sampling time*, which allows to include approx. 10 samples in time of characteristic bending. If drying is finished too quickly, increase *Samples quantity* or *Sampling time*.

### Notes:

1. Before main measurement remember about deactivating of chart displaying.
2. To improve operation it is possible to use *Promas* software (available on demand), which generates precise drying chart.

## 14. Proper moisture

Before measurement carefully prepare the sample (as described in chapter Description of Thermogravimetric Analysis) and set correct drying parameters (see the diagram in chapter 11.6, description of the way of setting is in 11.4).

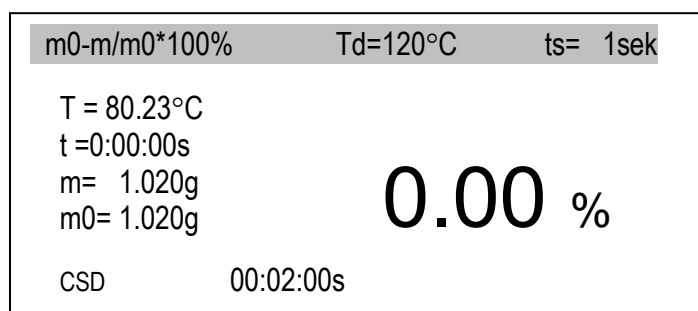

START

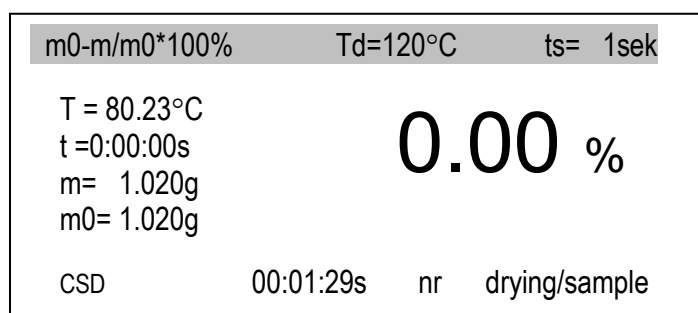

Place an empty single-use pan and tare the balance with  $\rightarrow T \leftarrow$  key. The indication should be  $m=0,000g$ . Open the drying chamber and using the pan handle place the single-use pan with the sample on the pan support. Close the chamber.

Start the measurement choosing **START** key.

In the lower line the time left to end the measurement and successive measurement number is displayed. Drying in progress is signalled with alternating **SAMPLE / DRYING** communicate.

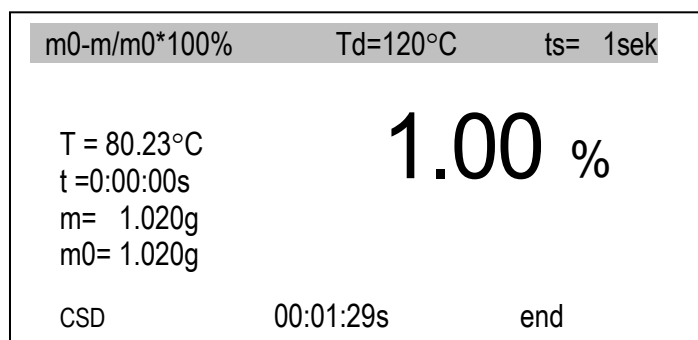

Wait until **END** communicate appears. Now read the result.

**Attention:** No **STB** communicate and **m0** sign in negative, marks acceptance of unstable initial mass value  $m0$ , caused by pressing the pan to chamber wall or by too fast sample drying, which can cause to measurement failures.

## 15. Connecting to a printer or computer – drying report

When drying process is finished measurement result can be send to printer or a computer via RS232C interface after using  key.

Measuring data can be also completed with text information. To enter text descriptions user can use moisture analyzer keys or connect a computer keyboard to PS2 port at the back of the device. Using computer keyboard enables to control all scale functions.

Using navigation keys and *ENTER* key choose *Drying chart* and disable or enable printing and displaying the chart. Set necessary options: *Product name*, *Operator* and with the connected computer keyboard enter text information for printed report(maximally 19 signs). The set of available signs is presented on next site. Option *Remarks* is designed to inscribe bigger amount of text using computer keyboard.

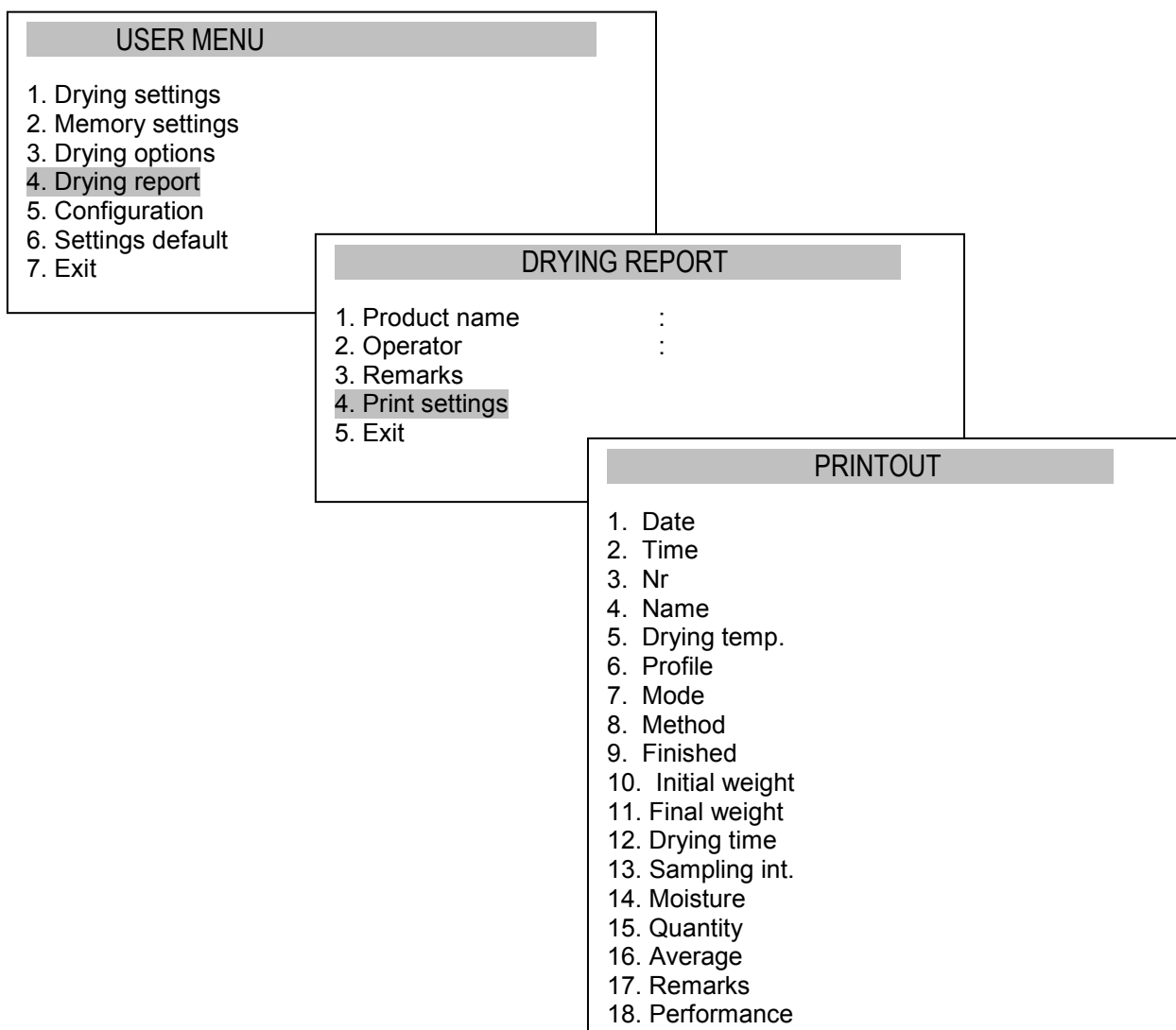

Using moisture analyzer keyboard user can inscribe signs: 0, 1, 2, 3, 4, 5, 6, 7, 8 and 9 (only digits).

A set of characters available using computer keyboard (PS2) while you use *Product name, Operator or Remarks*:

1 . , ' ? ! " - ( ) @ / : \_ ; + & % \* = < > \$ [ ] { } \ ~ ^ ' # |  
 2 A B C a b c  
 3 D E F d e f  
 4 G H I g h i  
 5 J K L j k l  
 6 M N O m n o  
 7 P Q R S p q r s  
 8 T U V t u v  
 9 W X Y Z w x y z  
 0 space

Erasing the mark and move the cursor to the left: the navigation key ← or BackSpace (computer keyboard).

To print the drying report press  key.

Drying started:	
-----	
Date:	
Time.:	
Serial number:	
Drying parameters	
-----	
Product	
Drying temperature :	
Drying profile :	
Mode :	
Calculation :	
Finished :	
Initial weight :	
Final weight :	
Drying time :	
Sampling interval:	
Moisture :	
NOTE:	
The analysis performed by:	
---	

It is possible to set necessary serial port parameter values (default settings: 8bit, 1stop, no parity, 4800bps). To use *RS232C Settings* option press  key (weighing mode) and pres *MENU* key.

Moisture analyzer is equipped with RS232C, USB or Wi-Fi interface. Required drivers and manual can be found on CD disc added to scale.

## 16. Moisture analyzer options

Moisture analyzer options:

- quantity of measurements ( $\Sigma$ ) and average from series of humidity measurements displaying (X),

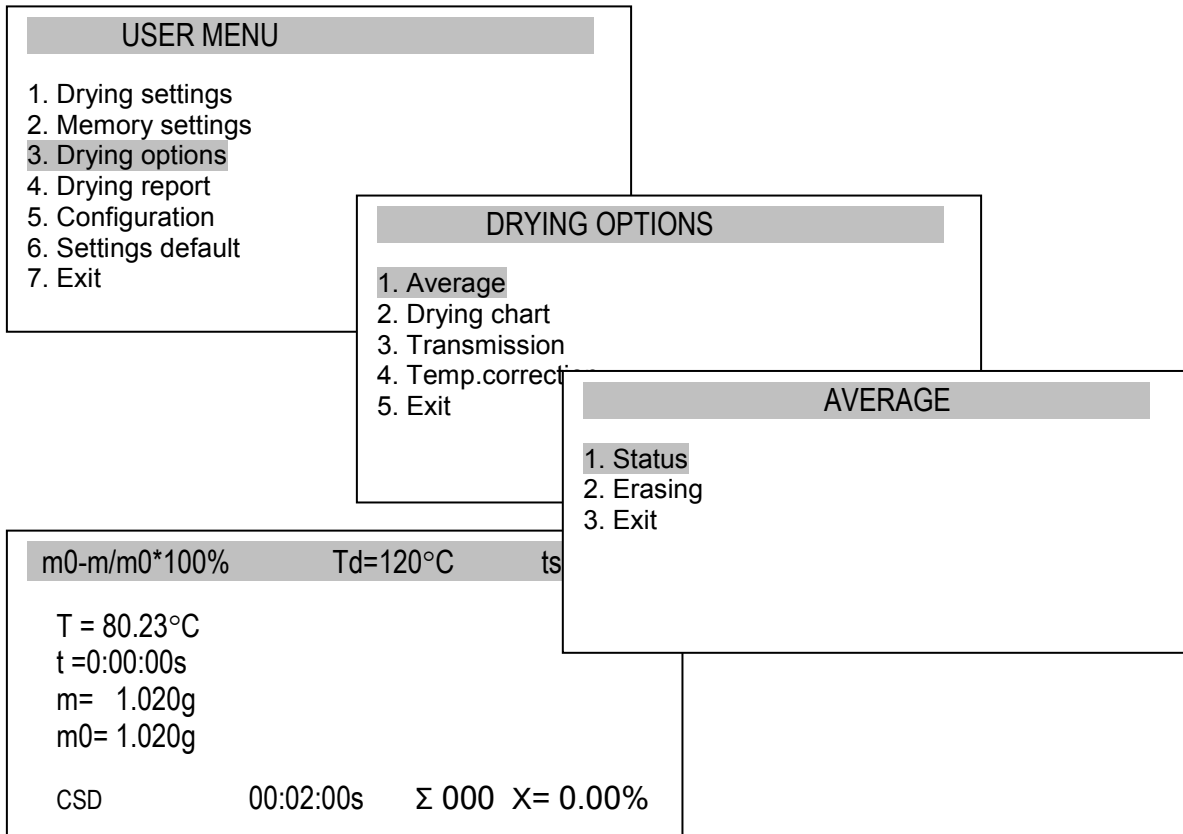

- drying chart displaying

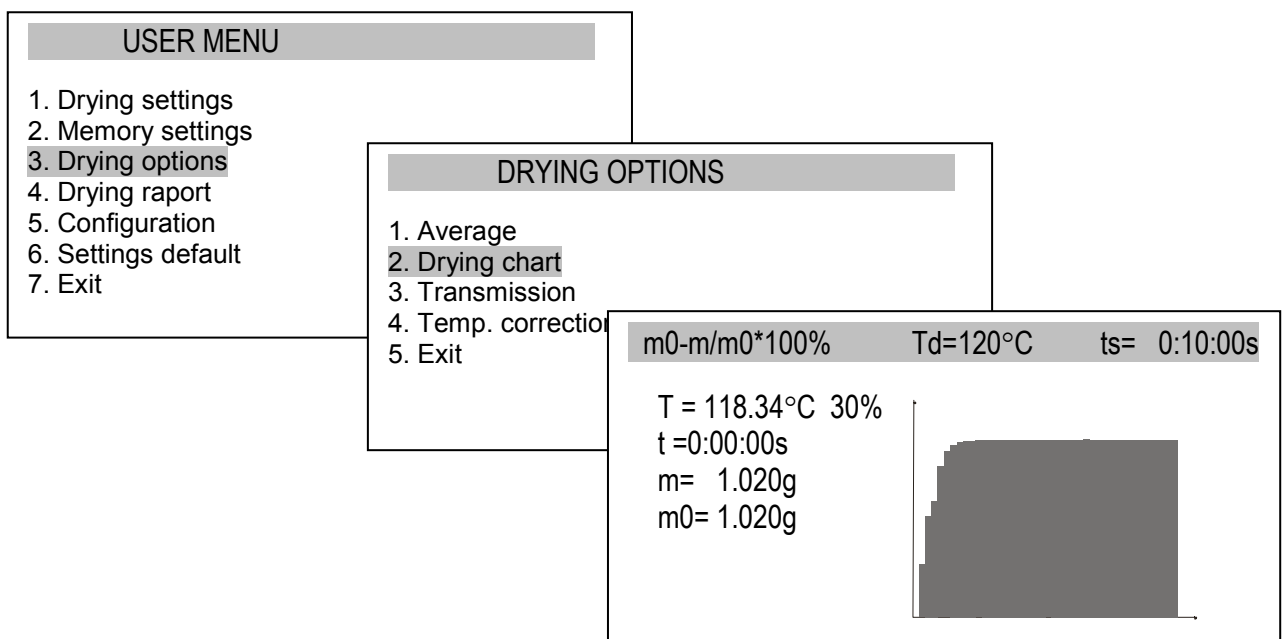

- transmission of all successive weight measurements (samples) by serial connection (measurements are printed or saved on computer using *PROMAS* software).

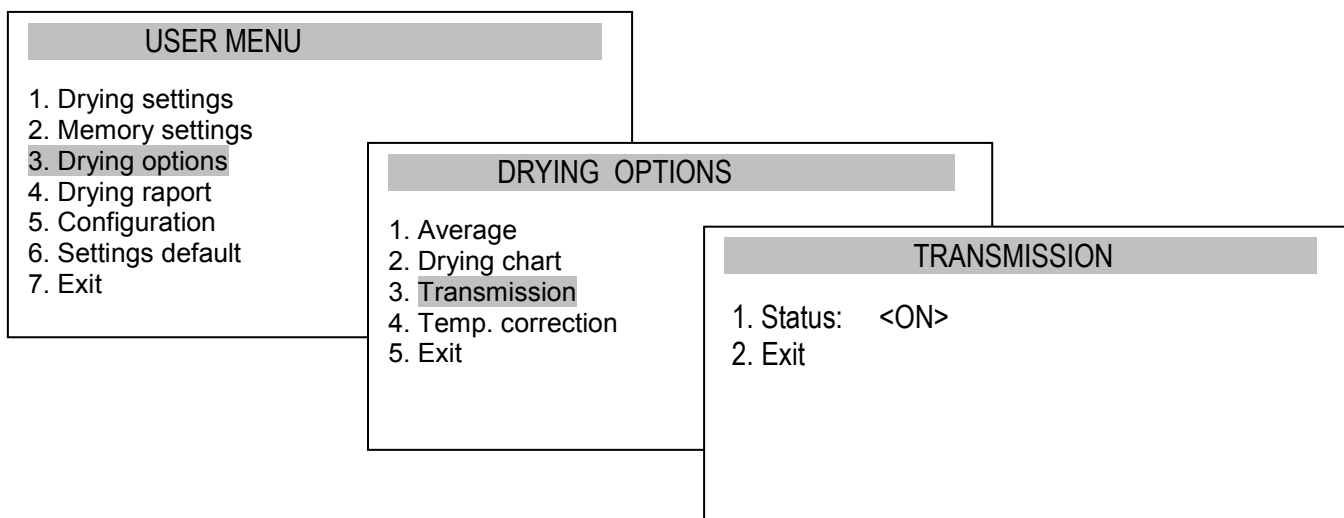

- correction of moisture analyzer internal thermometer indications based on measurement of two different temperatures, it is suggested to use the highest and lowest temperature set by user, for example 70 °C and 100 °C ;  
 In order to make correction inscribe T1 and T2 temperature values indicated by internal thermometer and corresponding values indicated by control thermometer and set *Status* to *ON*.

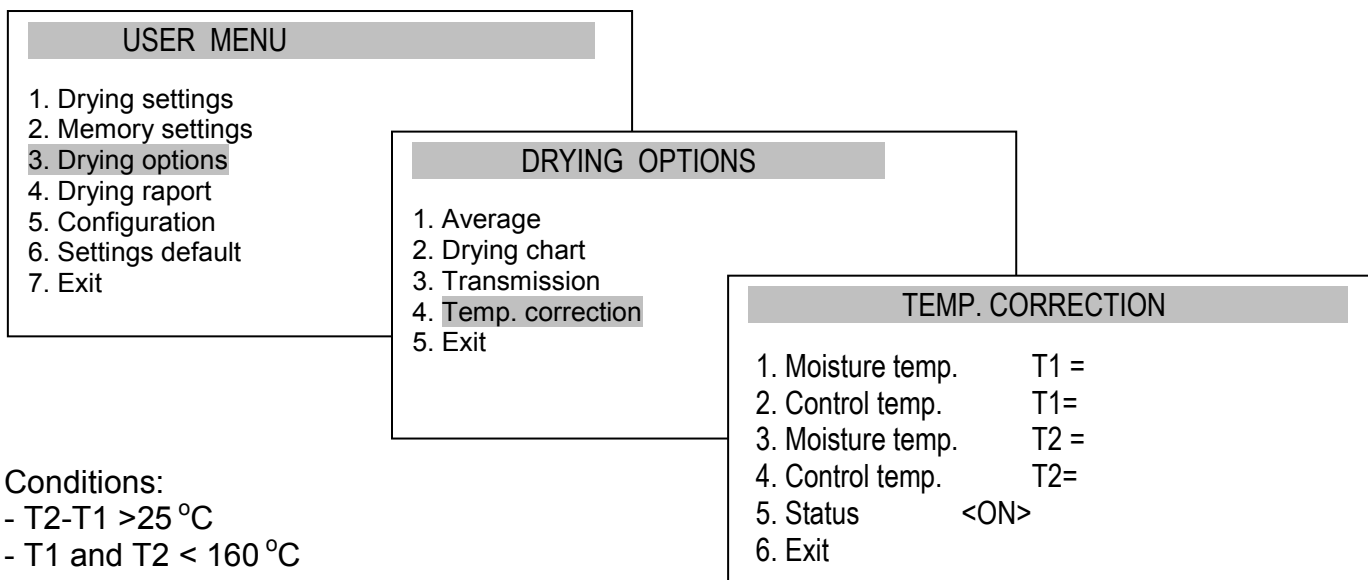

Conditions:  
 -  $T2 - T1 > 25\text{ °C}$   
 -  $T1 \text{ and } T2 < 160\text{ °C}$

If the conditions are unfulfilled during changing status to ON communicate *Error !* will be displayed.

The largest possible to correct difference between internal and external thermometer indications is 20° C.

Recommended thermometer type: PT-105 with GT-105 probe.

The way of entering control thermometer probe to moisture analyzer drying chamber:

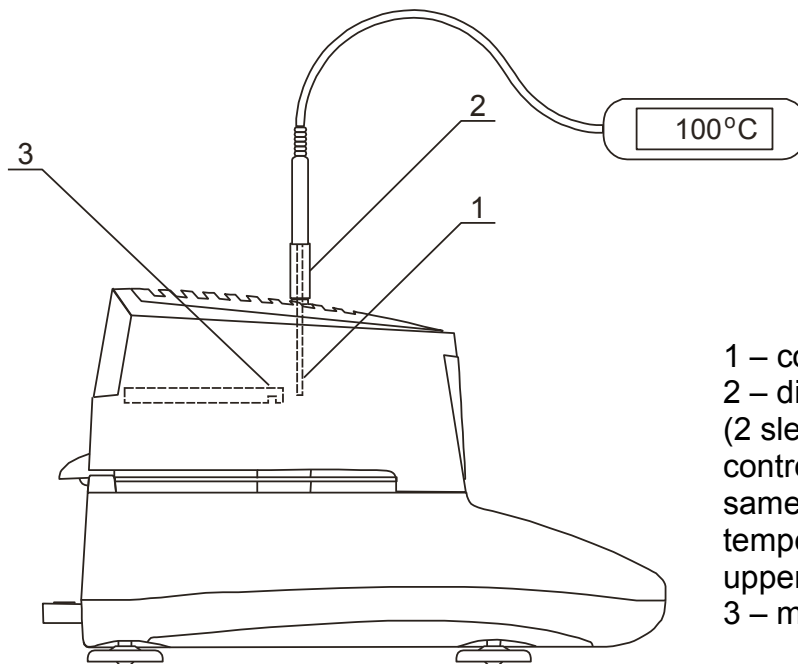

- 1 – control thermometer probe
- 2 – distance sleeves 2x20mm  
(2 sleeves ensure that position of control thermometer probe is the same as moisture analyzer internal temperature sensor, 1 sleeve – on the upper edge of the single-use pan)
- 3 – moisture analyzer internal sensor

Before executing temperature correction (inscribing T1 and T2 temperature) drying cycle must be made with inscribed T1 temperature and drying time 15 minutes. It is suggested to put the material sample on the pan. At the end of drying process write down moisture analyzer temperature indication ( T value on the left side of moisture analyzer display) and control thermometer indication.

Both indications are needed for correction:

TEMP. CORRECTION	
1. Moisture temp.	T1 =
2. Control temp.	T1=
3. Moisture temp.	T2 =
4. Control temp.	T2=
5. Status	<ON>
6. Exit	

Subsequently make drying cycle for T2 temperature (drying time as above 15 minutes) and write down indications again.

This way both T2 indications are inscribed:

TEMP. CORRECTION	
1. Moisture temp.	T1 =
2. Control temp.	T1=
3. Moisture temp.	T2 =
4. Control temp.	T2=
5. Status	<ON>
6. Exit	



**Attention:**

Moisture analyzer internal thermometer correction is made with internal thermometer and control thermometer on the same level above the sample.

The temperature indicated by thermometer situated on some level above the sample can differ from real temperature of the sample. In this case if there is a need for temperature indication correction simply lower the level of control thermometer by removing distance sleeve (picture on page 31 position 2). Put on the pan a layer of material sample with determined thickness and perform correction (description on previous page). During correction thermometer can't touch the sample.

Correct:

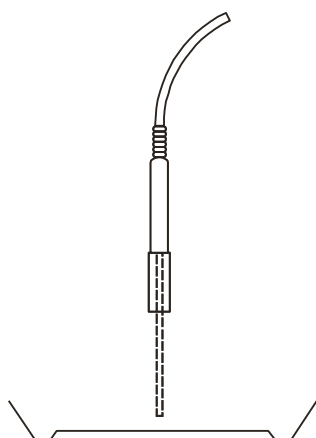

Incorrect:

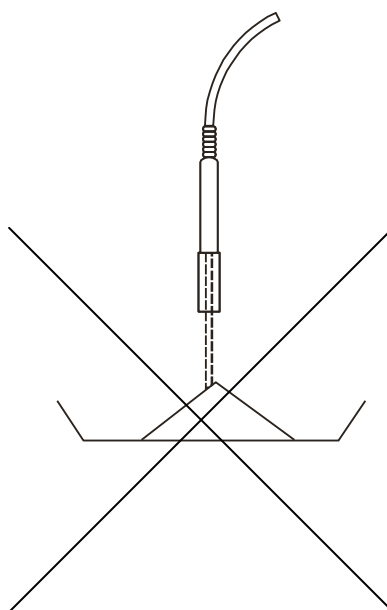

## 17. Testing and calibration

To check the weighing function of balance – drier, switch it to the simple weighing ( $\uparrow$  key) and check it by putting precisely weighed object, e.g. calibration weight F2 (OIML), equal to device measurement range. In case of any inaccuracies perform the balance calibration. It is performed by activating the calibration function, available in special functions menu, and putting the calibration weight on the pan according to indications on the display (see *Sensitivity calibration function*).

Control of humidity measurement precision requires use of standard substance – disodium tartrate (di-Sodium tartrate dihydrate  $C_4H_4Na_2O_6 \cdot H_2O$ ). For the control use 5 g sample, setting: quick mode, calculations method:  $m_0 - m / m_0 \cdot 100\%$ , temperature  $150^\circ C$ , sampling time 10 s, samples amount 4 and drying time 00:15:00s.

The result should be contained in range 15.61 – 15.71%.

## 18. Moisture analyser as a balance

The moisture analyser may be also used as a normal balance. To switch between analyser / weighing mode press ↵ key.

During moisture analyzer work as a normal balance essential influence on measurement result has the proper setting of moisture analyzer level (level indicator is at the back of the device) and precise balance calibration. Setting balance level is important after each putting moisture analyzer into new place .

During normal weighing *Menu* key opens directly *Configuration* window, where the *Units* option is available, *Auto-zeroing*, scale calibration and default settings.

### 18.1 Units

In order to change the unit used in balance and moisture analyzer use *MENU* key, in *Configuration* window (*User Menu* window shows up when the normal weighing mode is off).

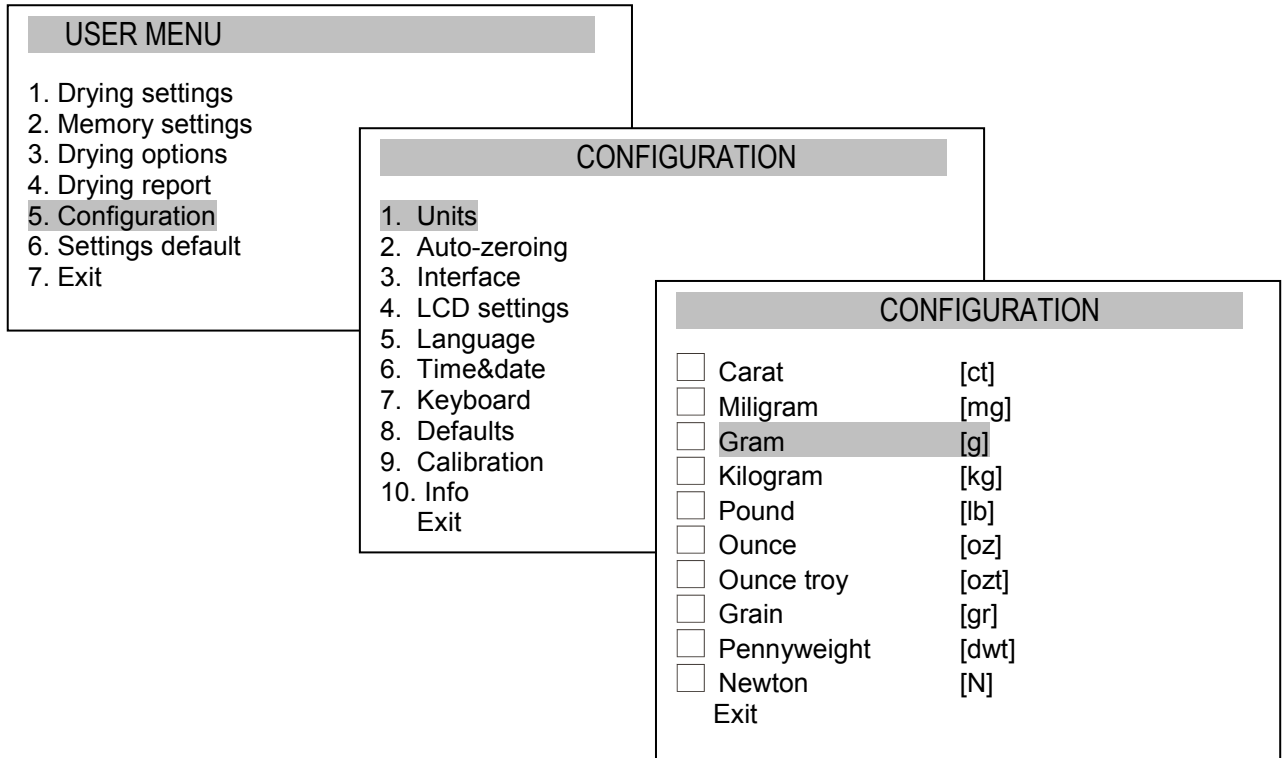

Choice of unit is made using navigation keys and *ENTER* key.

## 18.2 Auto-zeroing

Auto-zeroing function causes that the close to zero indication will be corrected automatically and when the pan is unbiased zero indication will be hold independently even when environment conditions change (temperature, air density etc).

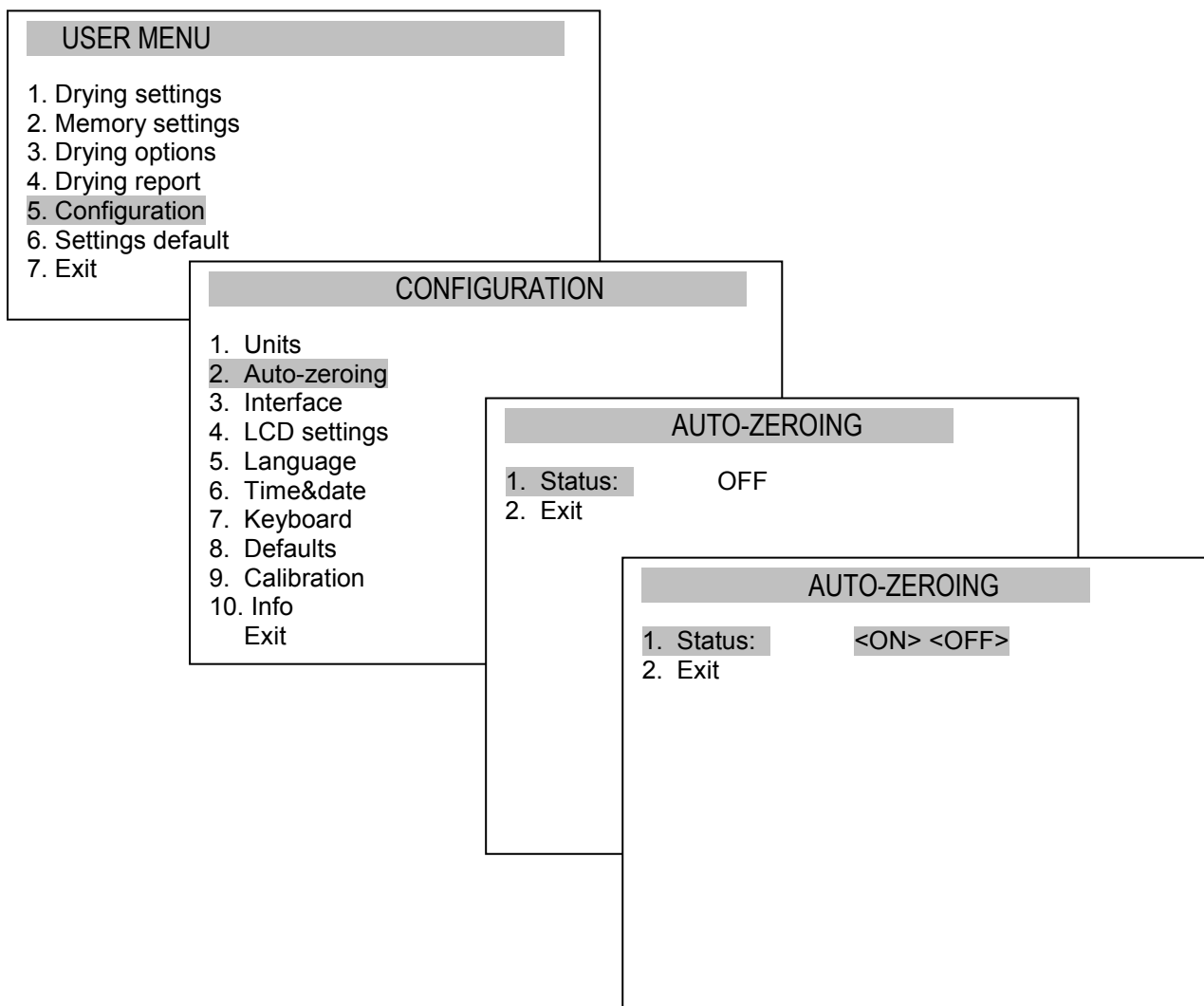

In order to turn on *Auto-zeroing* function use navigation keys and *ENTER* key, choose *Status ON*.

### 18.3 Calibration

Calibration with external weight standard should be performed in case indications exceed permissible error (for example more than 5 graduation overflow). To scale calibration use weight standard presented in technical data table (or more precise).

Depending on the value of gravity acceleration the producer sets the scale to specific location of use.

If the location of use change the scale should be calibrated once again

**Attention:** Scale sensitivity error doesn't cause directly humidity error thanks to percentage calculation formula.

In order to calibrate the balance use *MENU* key and *Configuration* option, and then *Calibration*.

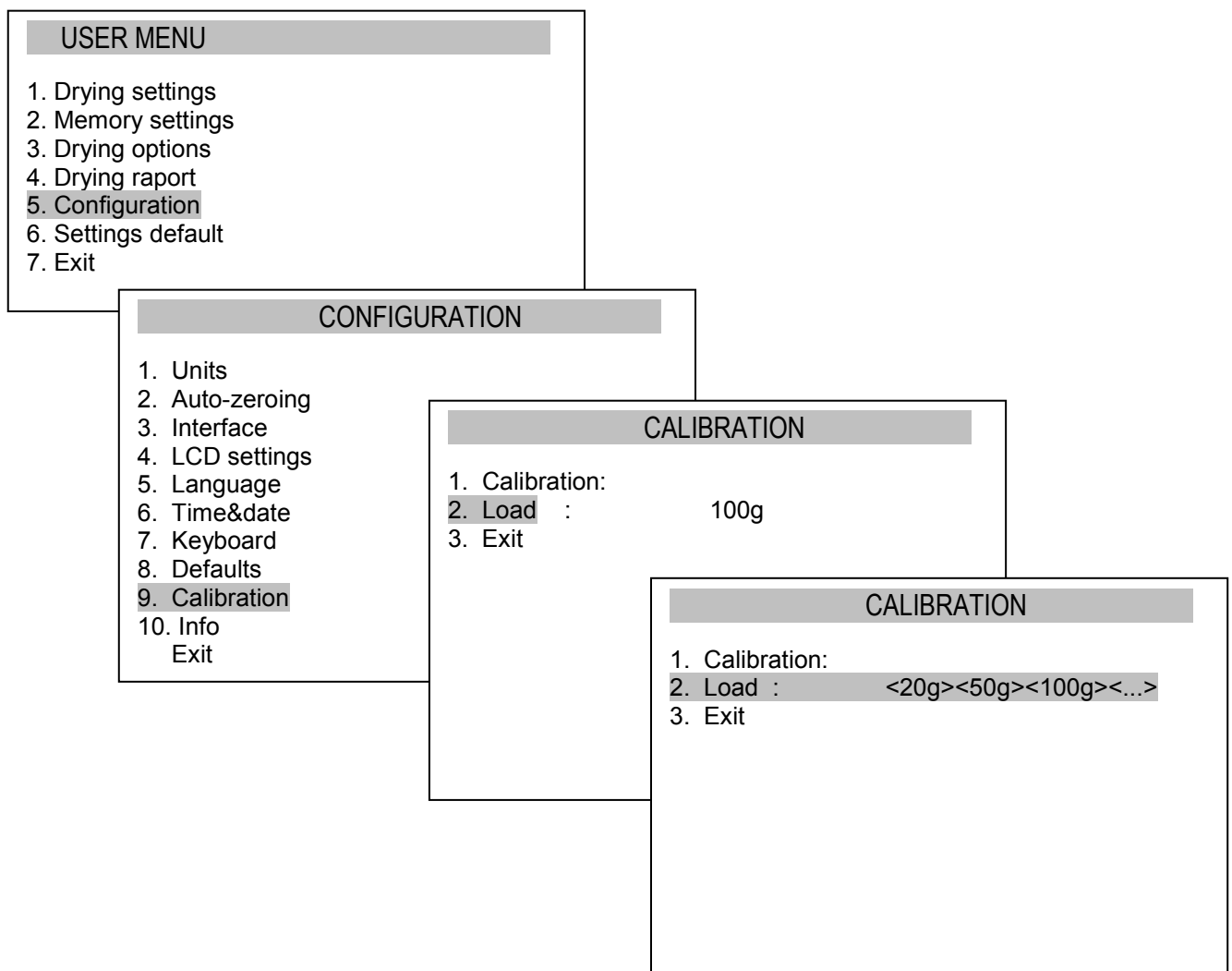

*Load* enables to inscribe standard mass value that will be used to calibrate. User can choose from few values or inscribe his own value.

After setting the standard of mass prepare single-use pan, put the standard and choose *Calibration* option by pressing *ENTER*.

**CONFIGURATION**

1. Units
2. Auto-zeroing
3. Interface
4. LCD settings
5. Language
6. Time&date
7. Keyboard
8. Defaults
- 9. Calibration**
10. Info

Exit

**CALIBRATION**

- 1. Calibration:**
2. Load :           100g
3. Exit

**CALIBRATION**

Please wait ...

**CALIBRATION**

Taring

**CALIBRATION**

Put load

**CALIBRATION**

Please wait ...

◀ ▶

100.000g

Put the standard of mass on the pan.

Displaying standard of mass value means that the calibration is done.

## 19. Maintenance and repairs of small defects

1. A moisture analyser should be kept clean.
2. Take care that no dirt gets between the casing and the pan. If found any, remove the pan (lift it up), remove dirt and then replace the pan.
3. In case of improper operation caused by a short-lasting power supply decay, unplug the moisture analyzer from the mains and then plug it again after few seconds.
4. It is forbidden to make any repairs by unauthorised persons.
5. To repair the scale, please contact an authorised service centre. Moisture analyzers can be sent for repair as messenger delivery only in original package, if not, there is a risk of damaging the moisture analyzers and losing guarantee.

### *Measuring problems:*

Problem	Solution
A sample burns down	Reduce temperature Use glass fibre filter on the top of the sample Reduce sample quantity and distribute it uniformly
Drying lasts too long	Increase temperature Reduce sample mass
A sample loses weight before measurement	Take out the pan and put a sample outside the chamber
A sample is liquid or paste	Use glass fibre filter
A sample does not consist of enough volatile matters	Enlarge a sample

**Troubleshooting:**

Display indication	Possible cause	Remedy
Initial heating Td temperature exceeds 105°C, the sensor does not react when touched with a finger	The temperature sensor is damaged.	Contact an authorised service point.
Initial heating Td temperature does not reach 105°C during 3 minutes time, the halogen heater(s) do not light.	The heater is damaged.	Replace the heater.
"Test ..."	Auto-tests in progress / electronic unit damage	wait for 1 minute
" - - - - "	The moisture analyzer is during zeroing / mechanical damage	wait for 1 minute check if the moisture analyzer is placed on stable ground, not affected by vibrations
„Tare range exceeded“	Tare key pressed during zero indication	Moisture analyzer indications must be different than zero
„Zeroing range exceeded“	Permissible zeroing range was exceeded	Remove the load from the pan
„Weighing range exceeded“	Permissible weighing range (Max +9e) was exceeded	Reduce the load
„Measuring range exceeded (+)“	Upper limit of analog-digital transducer measuring range was exceeded	Remove the load from the pan
„Measuring range exceeded (-)“	Lower limit of analog-digital transducer measuring range was exceeded	Check if there are all necessary pan elements

# Declaration of Conformity

The last two digits of the year in which the CE marking was affixed: 15

] We:

**AXIS** Spółka z o.o. 80-125 Gdańsk, ul.Kartuska 375B, Poland

confirm with all responsibility that moisture analysers:

*ATS60, ATS120, ATS210 oraz BTS110 i BTS110D*

marked with CE mark comply with the following:

1. EN 61010-1:2011 standard Safety requirements for electrical equipment for measurement, control and laboratory use. General requirements harmonized with the directive 2006/95/WE (Low Voltage Directive).
2. EN 61000-6-1:2008, PN-EN 61000-6-3:2008 norm Electromagnetic compatibility (EMC) and EN 61000-4-3:2007 + A1:2008 + A2:2011 Methods of measurement and examination – harmonized with 2004/108/WE.

Additional information:

Conformity evaluation for the Directive 2006/95/WE and 2004/108/WE was carried out by Research Laboratory of Electrotechnology Institute Division Gdańsk, accredited by PCA (Reports No. 032/LMC-904 and 030/905/2011 from 2.03.2011 and 7.03.2011, 042/LBS-904/2011 and 035/LBS-904/2011 from 14.04.2011).

Per pro Director of AXIS Sp. z o.o.:

Production Manager

Jan Kończak



Date: 14-11-2014



## Appendix

### Drying parameters for different substances (examples)

No	Substance	Initial weight (g)	Temperature (°C)	Preparation	Analysing time (min)
1.	Acrylate seal	3		mix a sample	9
2.					
3.	Granulated sugar	3	90		3
4.	Icing sugar	5	130		20
5.	Butter	2	140	tear up a foil	4
6.	Margarine	2	160		4
7.	Ketchup	2	120		18
8.	Mustard	3	80		19
9.					
10.	Peanuts	3	100	grind into thick powder	6
11.	Nuts in shells	3	100	grind into thick powder	4
12.	Nuts	2	100	grind into thick powder	4
13.	Peanuts	3	100	grind into thick powder	4
14.					
15.					
16.	Cheese	2	160		13
17.	Cottage cheese	6	140	mix a sample	
18.	Cottage cheese (rural)	1	130	mix a sample	8
19.	Mozzarella cheese	2	160		11
20.	Melted cheese	3	160		5
21.					
22.	Dry beans	3-4	105	grind a sample	5
23.	Bean	5	150	grind a sample	10
24.	Pea	4	135	grind for 30 sec.	8
25.	Dry peas	5-7	110	grind a sample for 10 sec.	10
26.	Dry carrot	5.5-6	120	grind a sample	3
27.	Dry corn	5-7	110	grind a sample	10
28.	Dry potato pieces	3	130	divide a mass	6
29.	Lentil	4	135	grind a sample for 30 sec.	6
30.	Corn starch	2	160		5
31.	Oily seeds	3-4	90	grind a sample for 1 min	8
32.	Rice	4	105	grind a sample for 30 sec.	13
33.	Rye	5	150	grind a sample	12
34.	Beetroot	5	150	grind a sample	9
35.	Sesame seeds	3	130		8
36.	Soya-bean flour	5	95		5
37.	Sunflower seeds	4	100	grind a sample for 2 min	4
38.	Cotton seeds	3-4	110	grind a sample for 1 min.	6
39.	Wheat flour	6	130		
40.	Wheat flakes	4	150	grind a sample	7
41.	Water to flour	2-3	90		10
42.	Plastic rag	1	160		4
43.	Natural rag	1	160		14
44.					
45.	Feeding stuff	3-4	150		6
46.	Pig feeding stuff	4-5	160	mix a sample	21
47.					
48.	Coffee	2	150		8
49.	Instant coffee	5		mix a sample	10
50.	Coffee seeds	4	120	grind a sample for 1 min.	8
51.	Cocoa	3	105		4
52.	Cocoa seeds	4-5	130	grind a sample for powder	8
53.	Chocolate	2	103		10
54.	Grinded chocolate	2-3	90		10
55.	Almonds with caramel	4	80	grind into thick powder	5
56.	Normal almonds	3	100	grind into thick powder	5
57.	Almonds	3	100	grind into thick powder	5
58.					
59.	Tobacco	2	100	tear up into pieces	16
60.					
61.	Multivitamin bars	3	115	grind into thick powder	3
62.	Mint pastilles	3	90	grind into thick powder	3

63.	Sticks	3-4	75	grind into powder	9
64.					
65.	Skimmed milk	5	110	mix a sample	
66.	Skimmed milk powder	5	90		6
67.	Fat milk powder	5	100		6
68.	Whole milk	5	110	mix a sample	
69.					
70.					
71.	Concentrated orange juice	2-3	115	mix a sample	13
72.					
73.	Dry chicken excrements	4	140		8
74.					
75.	Soap	3	120	pinch some pieces	6
76.	Starch derivatives	3	150		12
77.	Starch glue	2	100	mix a sample	9
78.	Detergent	2	160		12
79.					
80.	Textile	1	85	separate fibres	3.6
81.	Materials for bricks	7	160	distribute a sample	20
82.	Silicon sand	10-14	160		1.9
83.	Dolomite	10-12	160		6
84.	Loess soil	3	160	cut into small pieces	15
85.	Ceramics clay	3	160	cut into thin slices	9
86.	Limestone	12-14	160		5
87.	Glass powder	8-10	160		5
88.	River water	4	160	mix a sample	20
89.					
90.	Active coal	10	80		10
91.	Coal powder	4	160		4
92.	Natural chalk	8	160		2
93.	Granulated acryl	10-15	80		12
94.	Acryl ester	2		mix a sample	19
95.					
96.	Cellulose matter	2	130	tear up into pieces	5
97.	Photo paper	2	150	tear up in 1 cm <sup>2</sup> pieces	6
98.	Dialyse membrane	1	80	cut into thin slices	2
99.					
100.	Drawing ink	2	120		10
101.	Toner	3-4	40		
102.	Powder paint	2	120		4
103.					
104.	Dialyse membrane	0.5-0.7	80	cut into thin slices	2
105.	Leak stopper	3	160		7
106.	Glue dissolvent	2	140		10
107.					
108.	Latex	1-2	160		5
109.	Natural latex	2	160	mix a sample	6
110.	Balsam	1	130		8
111.	Soda bihydrate	2	160		12
112.	Ultramid	10	60		10
113.	Silicon gel	10	115		5
114.	Macrolon	10-12	80		15
115.	Plexiglas 6N	10	70		10
116.	Polypropylene	13	130		9
117.	Polypropylene	3	120		2
118.	Polystyrene solution	2	120		9
119.	Polystyrene	10	80		10
120.					
121.	Dissolvent	2	155	mix a sample	8
122.	Resin dissolvent	2	160	mix a sample	6
123.					













**Gram Precision S.L.**

Travesía Industrial, 11 · 08907 Hospitalet de Llobregat · Barcelona (Spain)

Tel. +34 902 208 000 · +34 93 300 33 32

Fax +34 93 300 66 98

[comercial@gram.es](mailto:comercial@gram.es)

[www.gram-group.com](http://www.gram-group.com)