



GRAM

SERIES

FV

120 / 120C / 220 / 220C

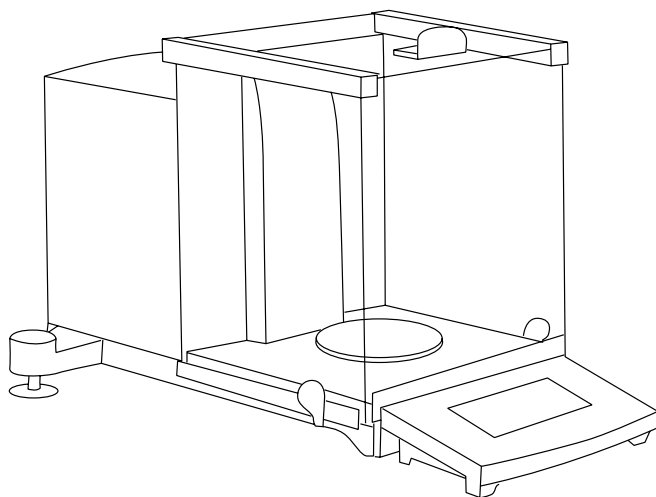

EN



OPERATION MANUAL



Introduction	3
Installation	4
Unpacking	4
Specifications	4
Environmental requirements	5
Setting up the balance	6
Using the balance	6
Basic weighing	6
Count weighing	7
Percent Deviation	8
Display and keyboard	8
Display symbols	9
Calibration	9
Auto-calibration (For models FV-120C and FV-220C)	10
Manual calibration (For models FV-120 and FV-220)	10
Parameters setting	12
Parameters index	13
RS-232 interface	14
Transmission Format	14
Data output mode	14
Auto Output Mode	14
Command Output Mode	15
External commands	16
Connection of balance and external device	17
Trouble shooting	17
Care and maintenance	19
Cleaning	19
Guarantee	20

ENGLISH

INTRODUCTION

To insure a proper operation of the balance, please read this manual completely before you start to use your balance.

The analytical balances are the latest products of years of research, design, development and infield testing. Every balance incorporated with the advanced electromagnetic force sensor technology, mechanical engineering and software technology offers the following features:

- Easy to operate and read results from a clear big LCD with a white backlight.
- Rapid weighing speed is 10 times faster than mechanical balances.
- Able to tare up to the maximum capacity of the balance.
- Multiple weighing modes can be selected.
 1. Normal weighing.
 2. Piece counting.
 3. Percentage weighing.
- Multiple weighing units conversion such as g and ct as standard units and the extra weighing units popularly used in some countries can be put into the balance on customer's request.
- A standard RS-232 interface for connecting peripheral device such as a computer or a printer.
- Dysfunction alarm.
- Easy to calibrate the balance.
- Display separate from body.

INSTALLATION

Unpacking

CAUTION: Handle with care all time!

Remove the balance from the carton carefully with the following items:

Packing List

- 1 Main body of the balance.
- 1 Pan.
- 1 Pan support.
- 1 AC power adapter.
- 1 User.
- 1 Standard weight (F1 Class).
- 1 Display.

It is recommended to save the cartons and packing materials for storing and transporting the balance or returning it for services.

SPECIFICATIONS

MODEL	FV-120	FV-220	FV-120C	FV-220C
Capacity	120g	220g	120g	210g
Readability	0,1 mg			
Repeatability	0,1 mg			
Linearity	0,2 mg			

Four-corner	0,2 mg	
Stabilization time	About 5 sec.	
Sensitivity	2 ppm	
Calibration	External	Automatic internal
Operating temperature	20 - 25 °C	
Pan size	90 mm	
Dimensions	320 x 300 x 470 mm	
Power	AC 110V-230V 50Hz-60Hz	

ENVIRONMENTAL REQUIREMENTS

As a precision instrument, the analytical balance requires an environment which is free from excessive air flow, corrosive, vibration and temperature or humidity extremes. The mentioned factors will affect displayed weighing readings.

- Keep weighing ambient clean and dry all time;
- The best operating temperature is about 20°C / 68°F at about 50% relative humidity.
- Use a stable AC main.
- Don't place the balance:
 - In direct sunshine.
 - Next to open windows or a door causing draft or rapid temperature charges.
 - Near heater or air conditioner.
 - Near vibrating, rotating or reciprocating equipment.
 - Near magnetic field or equipment which generates magnetic field.
 - On an unstable weighing table.
 - In areas where the danger of explosion exists.

SETTING UP THE BALANCE

Warm up the unplugged balance at an indoor temperature for two hours whenever moved it from a colder place, otherwise the accuracy will be affected by condensation of in side and surface of the balance.

- Place the balance on a stable and level work surface.
- Level the balance by turning the adjusting feet, checking the level indicator on the balance, until the bubble appears in the center of the circle.
- Put the parts of the balance as following sequence: dust guard, draft ring, pan support and pan.
- Plug in the AC adaptor.
- Check if the adaptor does match your main supply before plug in.

USING THE BALANCE

Note: To avoid dust, keep your balance door closed whenever it is not continually used.

Plug in and pre-warm your balance at least 30 minutes before weighing.





Basic weighing

1. Plug in the power, the balance will automatically proceed system initialization and display status of off.
2. Press the  key, the balance will display **0.0000g**.

3. Place the container on the weighing pan.
4. Press the  key.
5. Place the sample object in the container and close the doors.
6. Read out the value after display is stable.
7. Repeat the steps to weigh next object.

Count weighing



To decide the total number of the components of similar weights, first get the weight of a known number of the components as a reference, then we could get the average weight of the component. Then the amount of the components on the pan will be decided.

1. First set the sample components quantity refer **PARAMETER SETTING** (for example, if the amount of sample is 50 pcs, you should setup the C2-2).
2. Press the  key, the balance will display **0.0000g**.
3. Press the  key, till the balance will display **PCS mode**.
4. Place the sample on the pan, then press the  key, the balance will read the amount number of the samples. The unit displayed on the LCD display is PCS.
5. Add the sample components you want, you could read the value when **[0]** is on the display.
6. Press the  key to convert between counting mode and other mode. PCS indicates piece number.

Note: The sample value should not be less than readability value.

Percent Deviation

To calculate the percentage a weight varies from a reference:

- Keep the pan empty.
- Press the  key to zero the display.
- Put a weight or an object on the centre of the pan as the reference sample and close the doors.
- Press the , **100%** will be displayed.
- Remove the weight or the object from the pan.
- Put the object to be compared on the centre of the pan and close the doors.
- A value of the deviation between reference and comparison will be displayed.
- Press the  key to convert between percent mode and other mode. % indicates percent weighing

DISPLAY AND KEYBOARD

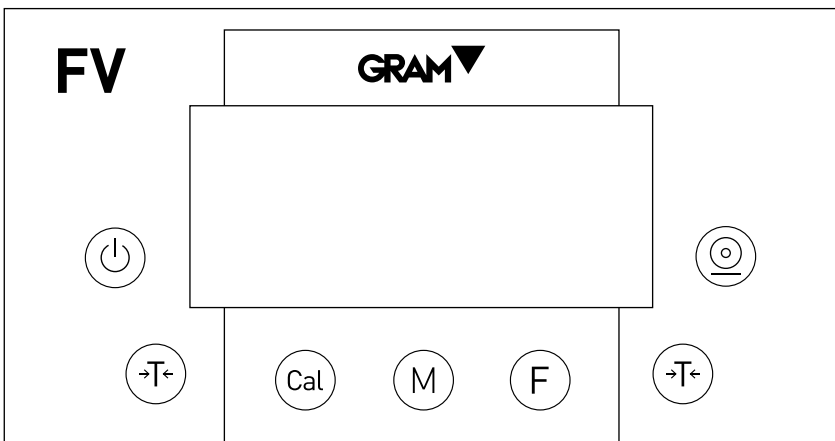

Display symbols

g	Gram
ct	Carat
lb	Pound
oz	Ounce
pcs	Piece counting mode
%	Percentage mode
♀	Stable indicator
Υ	Positive indicator
♂	Negative indicator
))))))	Waiting indicator
CAL in	Status of calibration
CAL dn	Loading the weights
CAL...	Calibrating
CAL up	Unloading weights
CAL-no	No calibration
CAL end	Calibration over
YE	Over the capacity
♂E	Under the capacity
-----	F key valid
.	Reading data
SAVE ---	Saving
S---END	Saving end

CALIBRATION

The analytical balance is designed on the equilibrium principle of electronic magnetic force. Among the various factors that may affect the accuracy of balance, gravity is the most obvious one. In different areas, there is different gravity, which results in different display value. We can remove this error by

calibrating the balance. That means whenever we move a balance from one area to another, we have to put a standard calibration weight (100.0000g for example) on the weighing pan and tell the balance here this weight is 100.0000g. Please make it as a reference to other weighings. This is the calibration of balance.

There are two ways to calibrate the analytical balance.

Auto-calibration (For models FV-120C and FV-220C)

- Plug in and pre-warm the balance at least 30 minutes.
- Turn on the balance.
- The balance will be calibrated automatically after several minutes and whenever the environment temperature changes out of a definite limit over 2°C or it Works out of the time limit over two hours.









Note: If “**CAL-no**” is displayed:

- Check if there is any object on the pan or the build-in calibration weight is loaded down onto the weighing mechanism while calibration.
- Remove the objects from the pan or raise up the build-in calibration weight from the weighing mechanism.
- Press the **(F)** key then **(Cal)** key to raise the build-in calibration weight up when it is on the weighing mechanism.

Manual calibration (For models FV-120 and FV-220)

In this mode, the parameter should be set to **C1-01**.





Take a balance with the capacity of 200g for example.

- Plug in and pre-warm your balance at least 30 minutes before calibration.
- Turn on the balance.
- Press the  key then the  key.
- Press the  key to select C1 and  to select 01.
- The message **✖C1” 01§** will be displayed.
- Press the  till display **C9**, then press the  key to store the set value, the display will show **“SAVE---“**.
- Press the  key, the display will show **“SAVE-end”**, the setup is finished.
- The display will show **✖0.0000 g §**.
- Press the  key, the display will show **CAL-in**.
- The message **CAL---** will be displayed about 3 seconds, then the display will show **CAL dn**.
- Put an external calibration weight of 100g (must be OIML Class F1) on the centre of the pan, then close the doors, the balance will calibrate the weight and display **CAL---**.
- The message **CAL up** will be displayed after calibration is over, remove the weight on the pan and close the door. The display will show **CAL...**, then will be CAL end and return to weighing mode.









Note: If the tolerance between the displayed value and the weight value is no more than 0.0001g the balance is well calibrated. Otherwise, repeat the calibration steps until it is well done.

PARAMETERS SETTING

You can reset the parameter setting as follow steps.

- Turn on the balance.
- Keep the pan empty.
- Press the  key and  key to enter Parameter Setting Mode after **0.0000g** is displayed.
- The display will show **✖Cx” 0y§** (x=1’9 y=0’6).
- Press the  key to select “**x**” and the  key to select “**y**”.

For example, when you will setup parameter to be C2-02, refer to the following instructions:

- Turn on the balance.
- After display is **0.0000g**, press the  key, then press the  key, “**C1-y**” will be display (y is stored in the balance at last time or stored default).
- Press the  key, the display will be “**C2-00**”, This is default in the balance.
- Press the  key till **C2-02** is displayed.
- Press the  key, “**o**” and “**C3-00**” will be displayed.
- Press the  key , the display will be “**SAVE ---**”, press the  key to store data or press the  without storage.
- After operation, “**S--END**” will be displayed.
- Setting is done and the balance will return to weighting status.

PARAMETERS INDEX

FUNCTION	SETTING	CONTENT
C1: Calibration mode	C1 -00	Auto-calibration with the build-in weight
	C1 -01	Manual calibration with external weight
C2: Set the basic number of samples for piece counting	C2 -00	10
	C2 -01	20
	C2 -02	50
	C2 -03	100
	C2 -04	1000
C3: Data control	C3 -00	j0j point tracking status
	C3 -01	1d
	C3 -02	2d
	C3 -03	3d
	C3 -04	4d
	C3 -05	5d
	C3 -06	Not for user
C4: Serial band rate	C4 -00	2400
	C4 -01	1200
	C4 -02	4800
	C4 -03	9600
C5: Data output rate	C5 -00	On zero stable
	C5 -01	On stable
	C5 -02	On command
	C5 -03	Continuous
	C5 -04	Unuse
C6: Sound of pressing key	C6 -00	No
	C6 -01	Yes
C7: Anti-interference	C7 -00	Weak
	C7 -01	Medium
	C7 -02	Strong
C8: With power screen will display	C8 -00	Yes
	C8 -01	No
C9		Unuse

RS-232 INTERFACE

With a standard build-in RS-232 interface, the balance is able to be connected to a printer or computer or other peripheral device for outputting weighing data.

Transmission Format

Transmission form: asynchronous transmission

Baud rate: 1200, 2400, 4800, 9600

Start bit: 1

Stop bit: 1

Data bit: 8

Parity: none

Code: ASCII

Data output format:

ST, +100.0000_{ijg} ←CR→ ←LF→ ←LF→ or

US, +100.0000_{ijg} ←CR→ ←LF→ ←LF→

- ST=STABLE (53H, 54H)
- US=UNSTABLE (55H, 53H)
- _i=SPACE (20H)
- ←CR→=CARRIAGE RETURN (0DH)
- ←LF→=LINE FEED (0AH)

Data output

Auto Output Mode

There are three modes:

A. Zero stable output mode

1. Set the parameter setting to C5-00.
2. Keep the pan empty before each weighing in this mode.
3. Put the object on the center of the pan after;0.0000 g is displayed.
4. A group of data will be output as the balance becomes stable (stability indicator appears).

B. Stability output mode

1. Set the parameter setting to C5-01.
2. A group of data will be output whenever the balance becomes stable (stability indicator appears). In this mode the objects could be weighed after tarring or with the Tare or Accumulation.

C. Continuous output mode

1. Set parameter setting to C5-03.
2. Once you turn on the balance and a printer or a computer which is perfectly connected to the balance, the data from balance will be output continuously in an interval of 3 seconds.

Command Output Mode

Set the parameter setting to C5-02.





A. Key output mode

The data from the balance will be output only by pressing the  key on the balance.

B. External command output mode

A command from a peripheral device connected to the balance will perform turning on/off the balance, calibration, mode selection, weighing unit conversion and printing. The balance would send a feedback whether the command is valid or invalid, as soon as it received a command from the peripheral device. Err'll be displayed if the command is invalid.

EXTERNAL COMMANDS

1. $\leftarrow 0 \rightarrow \leftarrow CR \rightarrow \leftarrow LF \rightarrow$ **ON/OFF** command (4F 0D 0A) as same as that of  key on the balance.
2. $\leftarrow T \rightarrow \leftarrow CR \rightarrow \leftarrow LF \rightarrow$ **Tare** command (54 0D 0A) as same as that of  key on the balance.
3. $\leftarrow C \rightarrow \leftarrow CR \rightarrow \leftarrow LF \rightarrow$ **Calibration** command (43 0D 0A) as same as that of key  on the balance.
4. $\leftarrow M \rightarrow \leftarrow CR \rightarrow \leftarrow LF \rightarrow$ **Mode selection** command (4D 0D 0A) as same as that of  key on the balance.
5. $\leftarrow P \rightarrow \leftarrow CR \rightarrow \leftarrow LF \rightarrow$ **Print** command (50 0D 0A) as same as that of  key on the balance.

CONNECTION OF BALANCE AND EXTERNAL DEVICE

Balance	Computer
9 pins	9 pins
2 _____ 2	
3 _____ 3	
5 _____ 5	

Balance	Series interface printer
9 pins	25 pins
2 _____ 2	
3 _____ 3	
5 _____ 7	

TROUBLE SHOOTING

Problem

Nothing displayed.

Causation

- No power.
- AC/DC main transformer is broken.

Solution

- Plug in the AC/DC Adapter.
- Replace the transformer.
- Send it to the services if it is broken again after replacement.

Problem

Displayed value is unstable.

Causation

- Bad working environment.
- The door of the chamber is not close properly.
- There is an objet or a crash between the pan and the shell.
- Unstable power supply exceed the limit.
- The object weighed is unstable (evaporation or absorpion of moisture).

Solution

- Improve working condition to avoid vibration or breeze.
- Close the door properly.
- Remove the objet and rotate the pan to avoid the crash.
- Connect an external AC main stabilizer.

Problem

There is a big error between the actual value and displayed value.

Causation

- The balance is not calibrated.
- The display is not tared before weighing.
- The balance is not properly leveled.

Solution

- Calibrate the balance.
- Press the  key to zero the display.
- Level de balance by turning the adjusting feed.

CARE AND MAINTENANCE

The analytical balance is a highly precision instrument, it should be handled carefully as other precision instrument in the laboratory.

- Do not use a sharp or rough object such as a pen or ball pen etc. To touch the keys use your finger only.
- Do not let any object fall on the pan, otherwise the weighing system will be damaged.
- Do not expose the balance in high temperature or mill dust environment for a long time.
- Do not disassemble the balance without permisión.
- It is better to cover the balance after use.
- Keep the balance clean and dry.

Cleaning

- Unplug the AC adapter before cleaning.
- Do not use any aggressive cleaning agent such as resolvent;
- Use a piece of wet smooth and soft cloth with some mild detergent such as soap
- Make sure no liquid enters into the balance.
- After cleaning, wipe down the balnace with a piece of soft and dry cloth.

GUARANTEE

This balance is guaranteed for one year from the delivery date. The guarantee covers any fabrication defect of the material.

During this period, **GRAM PRECISION, SL**, covers the manpower and the spare parts necessary to repair the scale.

This guarantee does not cover the failures caused by an inappropriate use or overload.

The guarantee does not cover the freight cost (transport) necessary to repair the balance.

NOTAS



Gram Precision S.L.

Travesía Industrial, 11 · 08907 Hospitalet de Llobregat · Barcelona (Spain)

Tel. +34 902 208 000 · +34 93 300 33 32

Fax +34 93 300 66 98

comercial@gram.es

www.gram-group.com