

Your success counts

Loop Powered, Multi Purpose Indicator for universal applications



Application examples: Salty Off-Shore conditions



Extreme cold weather at polar regions



Hot and sandy deserts

The F-Series is your first and safest choice for field mount indicators in safe and hazardous area applications. Especially in harsh weather conditions like rain, snow, salty atmospheres and temperatures between -30°C up to +70°C (-22°F up to 158°F).

Advantages

- Robust aluminum or stainless steel 316L field enclosure (IP67 / NEMA Type4X). It is so rugged, a truck can even stand on it!
- Intrinsically Safe available - ATEX, IECEx and CSA approval for gas and dust applications.
- Programming can be done by your own crew, with the sensible menu-driven structure, saving cost and irritation. Know one, know them all!
- Very diverse mounting possibilities: walls, pipes, panels or directly onto outdoor sensors!

Features

- Universal loop powered indicator.
- Input signal: 4 - 20mA with ultra low voltage drop <1V DC.
- Displays the actual value, measuring unit and loop current.
- Very large 26mm (1") digits.
- Piegraph indication: ten segments.
- Number of digits: 5 ½.
- LED backlight circuit, separated from the input circuit..
- Selectable engineering units for many different applications:
L- NL- mL - M³- AM³- NM³ - mg - g - Kg - TON- OZ- GAL - USGAL - IGAL - lb - bbL- cf - CUft - scf - p - rev - °C - °F - °K - % - M - mm - CM - mtr - inch - Ft - SQFt - Yd - PSI - psig - mbar - MbARG - bar - barg - bara - PA - PAG - KPA - KPAG - MPA - INHG - mmHg - mmH₂O - MH₂O - INH₂O- Ph - mV - mA - A - uS - PPM - RPM or no unit. (others on request).
- Auto backup of all settings.

Introduction

The F490 is a local indicator to display the actual process value, range and loop current. The measuring unit to be displayed is simply selected through an alfa-numerical configuration menu. No adhesive labels have to be put on the outside of the enclosure: a weather proof and user friendly solution! The configuration of Span, offset and number of decimals is done through software functions, without any sensitive dip-switches or trimmers. A wide selection of options further enhances the capabilities of this model, including Intrinsic Safety for hazardous area applications.

Hazardous areas

For hazardous area applications, this model is ATEX, IECEx and CSA certified as Intrinsically Safe for gas and dust applications, with an ambient temperature range of -30°C to +70°C (-22°F to +158°F).

Configuration

All configuration settings are accessed via a simple operator menu which can be password protected. Each setting is clearly indicated with an alphanumeric description, which avoids confusing abbreviations and baffling codes. Once familiar with one F-series product, you will be able to program all models in the series without a manual. All settings are safely stored in EEPROM memory in the event of sudden power failure.

Backlight

For those applications where readability during day and night is an issue, a white backlight is available with separated circuit from the input circuit. The display is a transfective type, which means that a high contrast reading is guaranteed in full sunlight as well as during the night. This backlight option is also available Intrinsically Safe.



Display

The display has 5 1/2 large 26mm (1") digits to show the main process information. At the bottom line, smaller 8mm (0.31") alfanumerical digits are available to display the measuring unit and additional messages in case of an alarm; range error e.g. With the piegraph, an actual range indication is offered in a single glance. If desired, additional information can be presented

after pressing the select key, like the actual loop current and the 0% and 100% process value. As the F490 has been designed for field mounted applications, a smart display update function has been incorporated to achieve a readable display even at -30°C (-22°F).



All info at a glance



Easy to install



Easy to program



Know one know them all!



Reliable



User-friendly

Overview application F490

The F-Series is your first and safest choice for field mount indicators in safe and hazardous area applications. Especially in harsh weather conditions like rain, snow, salty atmospheres and temperatures between -30°C up to $+70^{\circ}\text{C}$ (-22°F up to 158°F). The F490 takes operating energy from an input current (2-wire 4 - 20mA) and reduces installation cost. It accepts a wide range of process instruments, including flow (linear or square root), level, pressure and temperature transmitters. All these process parameters can be displayed in their own engineering units. The F490 is, like other F-Series, optional available with Intrinsic Safety for hazardous area applications.



Signal input

The F490 accepts 4 - 20mA input signals only. The input circuit is separated from the backlight circuit. The input signal type can be tuned and set by the user in the configuration menu without having to adjust any sensitive mechanical dip-switches, jumpers or trimmers.

Power requirements

The F490 is designed to be a loop powered indicator, which means it takes its operating energy from an input current (2-wire 4 - 20mA).



Robust, even a truck can stand on it!



Resistant to harsh weather

Enclosures

Various types of enclosures can be selected, all ATEX, IECEx and CSA approved. The F490 is supplied in an GRP panel mount enclosure as standard, which can be converted to an IP67 / NEMA 4X GRP field mount enclosure by the addition of a back case. Most popular is our robust aluminum field mount enclosure which is so rugged, even a truck can stand on it! This is also available with an extended backcover with undrilled preparation for direct meter mounting at the back side. For the most challenging environments, we have a durable high grade Stainless steel 316L enclosure. All enclosures have a IP67 / NEMA Type4X rating and EU or U.S. cable gland entry threads available.

Dimensions enclosures

Aluminum & GRP panel mount enclosure

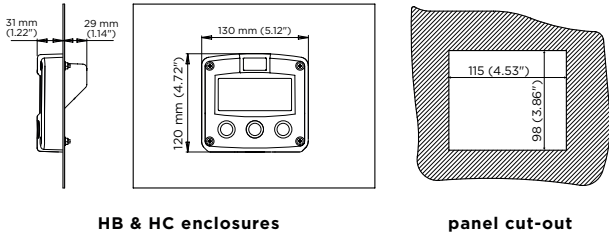

HB & HC enclosures

panel cut-out

Aluminum, GRP & Stainless steel 316L field mount enclosures

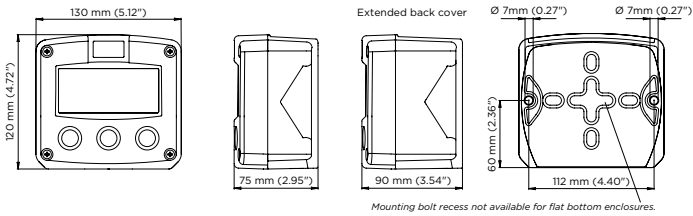

Cable entries

Aluminum / Stainless Steel

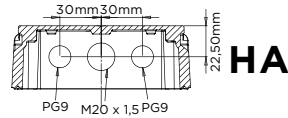

HA

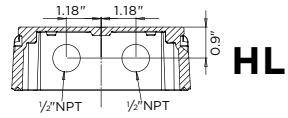

HL

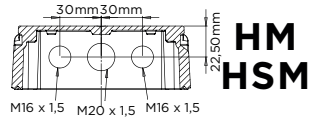

HM
MSM

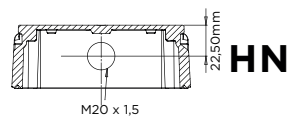

HN

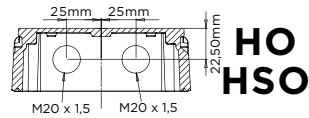

HO
HSO

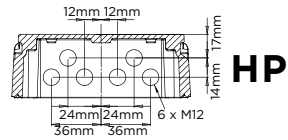

HP

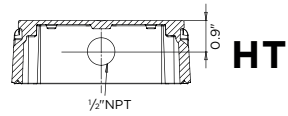

HT

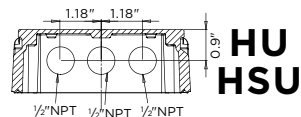

HU
HSU

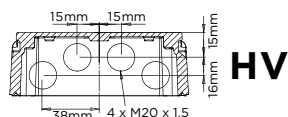

HV

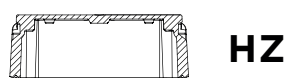

HZ

GRP

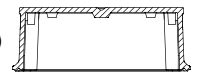

HD

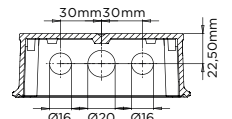

HE

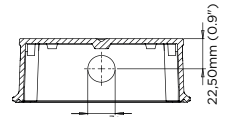

HF

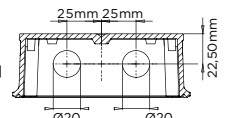

HG

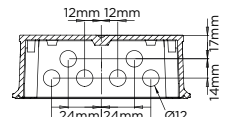

HH

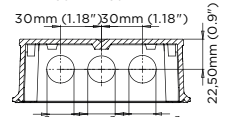

HJ

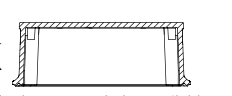

HK

Extended Aluminum

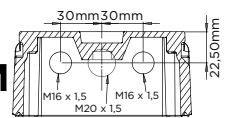

HBM

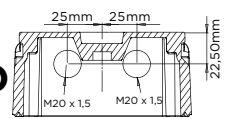

HBO

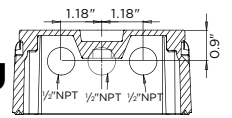

HBU

Display example - 90 x 40mm (3.5" x 1.6")

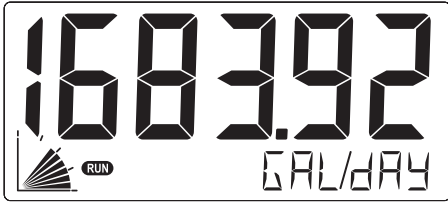

Display

Type	High intensity reflective numeric and alphanumeric LCD, UV-resistant.
Dimensions	90 x 40mm (3.5" x 1.6").
Digits	5 1/2 very large 26mm (1") digits. Various symbols and measuring units.
Option ZB	Transflective LCD with white LED-backlight. Good readings in full sunlight and darkness. Also available Intrinsically Safe.

Piegraph

Digits	10 segments.
Relation	To the min. and max. input signal (0 - 100%).

Displayed information

Digits	5 1/2 digits. (height 26mm / 1").
Units	L - NL - mL - M ³ - AM ³ - NM ³ - mg - g - Kg - TON - OZ - GAL - USGAL - IGAL - lb - bbL- cf - CUft - scf - p - rev - °C - °F - K - % - M - mm - CM - mtr - inch - Ft - SQFt - Yd - PSI - psig - mbar - MbARG - bar - barg - bara - PA - PAG - KPA - KPAG - MPA - INHG - mmHg - mmH2O - MH2O - INH2O - Ph - mA - A - uS - PPM - RPM - no unit.
Time units	/SEC - /S - /MIN - /M - /HR - /H - /DAY - /D
Note	Selecting "/-----" disables the time unit.
Decimals	0 - 1 - 2 - 3 - 4 or 5.

Terminal connections

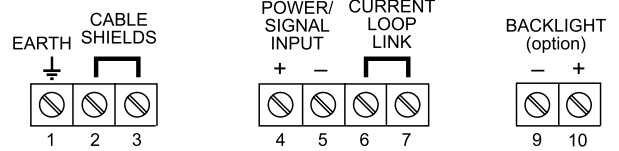

Configuration example F490-A-PL-XX-ZB

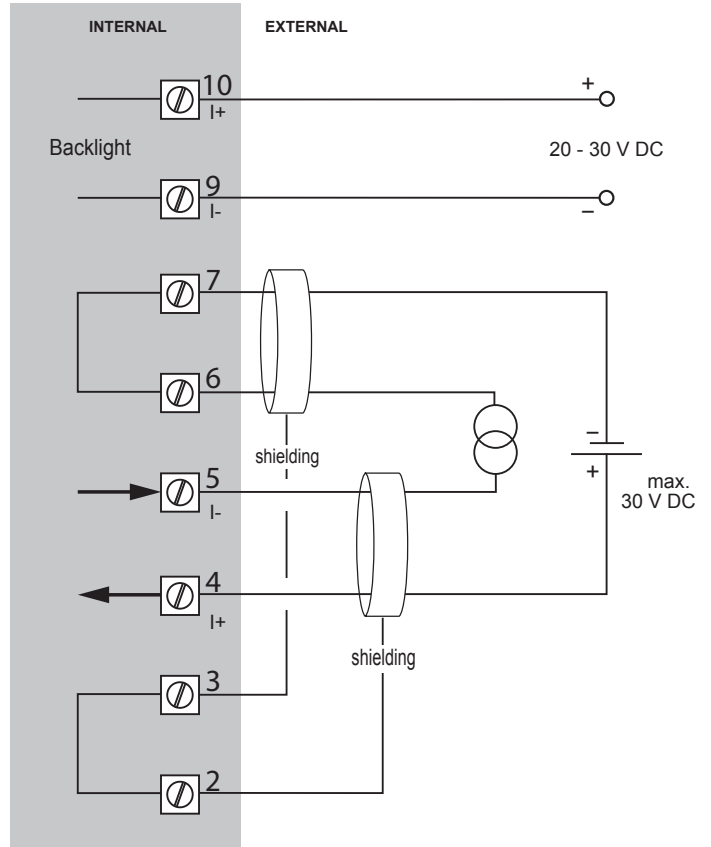

Hazardous area applications

The F490-XI has been certified according to ATEX and IECEx by KEMA and according to CSA c-us for use in Intrinsically Safe applications with an ambient temperature of -30°C to +70°C (-22°F to +158°F).

- The ATEX markings for gas and dust applications are:

Gas: **II 1 G Ex ia IIC T4 Ga.**

Dust: **II 1 D Ex ia IIIC T100 °C Da.**

- The IECEx markings for gas and dust applications are:

Gas: **Ex ia IIC T4 Ga**

Dust: **Ex ia IIIC T100 °C Da.**

- The CSA c-us markings are:

IS Class I/II/III, Division 1, Groups A to G.

Ex ia IIC / Class 1 Zone 0 AEx ia IIC T4.

It is allowed to connect up to two I.S. power supplies to power the unit and backlight. Consult the certificate for the maximum input and output values of the circuits.

Electrical safety

The input circuit of the indicator is designed such that it does not influence the intrinsically safe circuit to which it is connected. (In the USA the application is covered by the entity concept.)

Input circuit (terminals 4 & 5) in type of explosion protection intrinsically safe Ex ia IIC, with the following parameters: $U_i=30V$, $I_i=200mA$, $P_i=1.2W$, $C_i=0nF$, $L_i=0mH$ only for connection to a certified intrinsically safe circuit not exceeding these values.

Certificate of conformity KEMA 03ATEX1075 X issue 6

- IECEx KEM 08.0007X issue 2 • CSA.14.70002331



Intrinsically Safe terminal connections

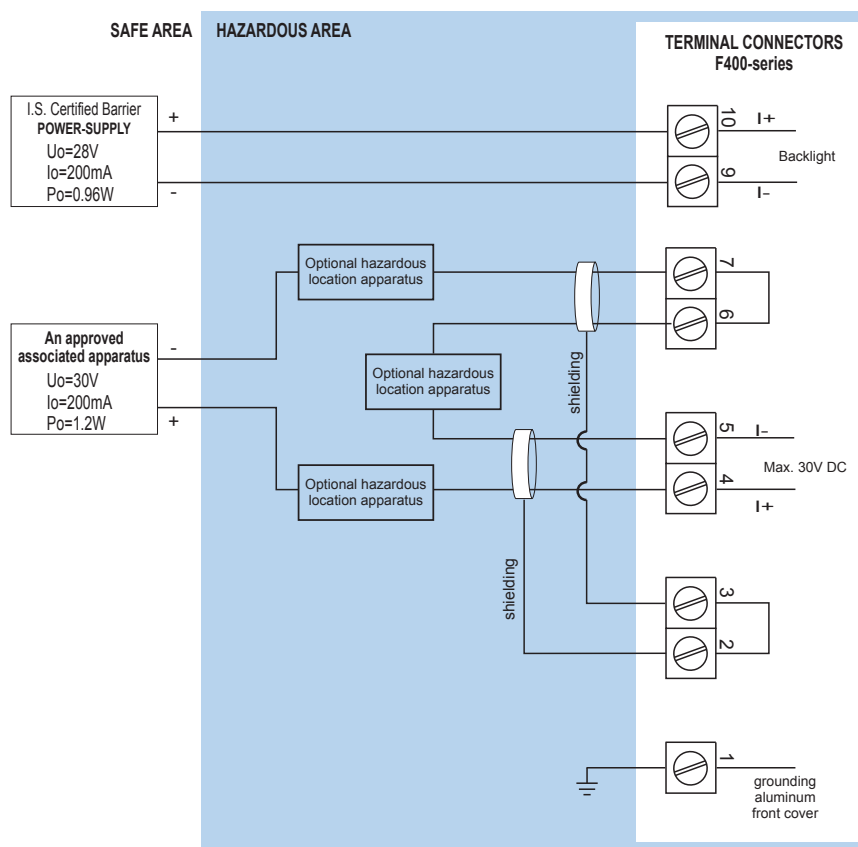

Power requirements

Type PL	Input loop powered from sensor signal 4 - 20mA
Type ZB	For backlight 20 - 30V DC. Power from IS source ($U_o = 28V$, $I_o = 200mA$, $P_o = 0.96W$ max.).
Note XI	For Intrinsically Safe applications, consult the safety values in the certificate.

Terminal connections

Type	Removable plug-in terminal strip. Wire max. 2.5mm ²
-------------	--

Data protection

Type	EEPROM backup of all settings. Data retention at least 10 years.
Password	Configuration settings can be password protected.

Ambient temperature

Safe areas	-30°C to +70°C (-22°F to +158°F).
Intrinsically Safe	-30°C to +70°C (-22°F to +158°F).

Directives & Standards

EMC	Directive 2014/30/EU, FCC 47 CFR part 15.
Low voltage	Directive 2014/35/EU
RoHS	Directive 2011/65/EU
ATEX / IECEx	Directive 2014/34/EU, IEC 600079-0, IEC 60079-11. IP & NEMA EN 60529 & NEMA 250
CSA	CSA 22.2 No. 157-92.
IP & NEMA	EN 60529 & NEMA 250.

Intrinsically Safe (Type XI)

ATEX	Gas: II 1 G Ex ia IIC T4 Ga. Dust: II 1 D Ex ia IIIC T100 °C Da.
IECEx	Gas: Ex ia IIC T4 Ga. Dust: Ex ia IIIC T100 °C Da.
CSA c-us	IS Class I/II/III, Division 1, Groups A to G. Ex ia IIC / Class 1 Zone 0 AEx ia IIC T4.
Ambient Ta	-30°C to +70°C (-22°F to +158°F).

Signal inputs - Sensor

Type A	4 - 20mA. Analog input signal can be scaled to any desired range within 4 - 20mA.
Accuracy	Resolution: 14 bit. Error < 0.01mA / ± 0.05% FS @ 20°C. Low level cut-off programmable.
Span	0.00001 - 199,999 with variable decimal position.
Offset	-99,999 / +199,999 units.
Update time	Four times per second.
Voltage drop	< 1V DC @ 20mA.
Relationship	Linear and square root calculation.

Operator functions

Displayed info	<ul style="list-style-type: none"> • Top line: main display value. • Bottom line: measuring unit and messages. • Piegraph: 10 segments related to input signal. • Actual sensor input value in mA. • Displayed value at 0%/100% of the input signal.
-----------------------	---

Enclosure

Window	Polycarbonate window.
Sealing	Silicone.
Control keys	Three industrial micro-switch keys. UV-resistant silicone keypad.

Panel mount enclosures

Dimensions	130 x 120 x 60mm (5.12" x 4.72" x 2.36") - W x H x D.
Panel cut-out	115 x 98mm (4.53" x 3.86") L x H.
Type HB	Die-cast aluminum panel mount enclosure IP65 / NEMA Type4X.
Weight	600 gr.
Type HC	GRP panel mount enclosure IP65 / NEMA Type4X, UV-resistant and flame retardant.
Weight	450 gr.

GRP wall / field mount enclosures

General	GRP wall/field mount enclosure IP67 / NEMA Type4X, UV-resistant and flame retardant.
Dimensions	130 x 120 x 75mm (5.12" x 4.72" x 2.95") - W x H x D.
Weight	600 gr.
Type HD	Cable entry: no holes.
Type HE	Cable entry: 2 x Ø 16mm and 1 x Ø 20mm.
Type HF	Cable entry: 1 x Ø 22mm ($\frac{7}{8}$ ").
Type HG	Cable entry: 2 x Ø 20mm.
Type HH	Cable entry: 6 x Ø 12mm.
Type HJ	Cable entry: 3 x Ø 22mm ($\frac{7}{8}$ ").
Type HK	Flat bottom, cable entry: no holes.

Aluminum wall / field mount enclosures

General	Die-cast aluminum wall/field mount enclosure IP67 / NEMA Type4X with 2-component UV-resistant coating. Extended back cover available with undrilled preparation for flowmeter mounting.
Dimensions	130 x 120 x 75mm (5.12" x 4.72" x 2.95") - W x H x D. 130 x 120 x 90mm (5.12" x 4.72" x 3.54") - W x H x D.
Weight	1100 gr. / extended enclosure: 1310 gr.
Type HA	Cable entry: 2 x PG9 and 1 x M20.
Type HL	Cable entry: 2 x $\frac{1}{2}$ " NPT.
Type HM/HBM	Cable entry: 2 x M16 and 1 x M20.
Type HN	Cable entry: 1 x M20.
Type HO/HBO	Cable entry: 2 x M20.
Type HP	Cable entry: 6 x M12.
Type HT	Cable entry: 1 x $\frac{1}{2}$ " NPT.
Type HB/HBU	Cable entry: 3 x $\frac{1}{2}$ " NPT.
Type HV	Cable entry: 4 x M20.
Type HZ	Cable entry: no holes.
Note	The extended back covers HBM/HBO/HBU, require type XX.

Stainless steel 316L wall / field mount enclosures

General	Die-cast stainless steel 316L wall / field mount enclosure with flat bottom. IP67/NEMA Type4X.
Dimensions	130 x 120 x 75mm (5.12" x 4.72" x 2.95") - W x H x D.
Weight	2700 gr.
Type HSM	Cable entry: 2 x M16 + 1 x M20.
Type HSO	Cable entry: 2 x M20.
Type HSU	Cable entry: 3 x $\frac{1}{2}$ "NPT.
Note	Type HSM/HSO/HSU, require type XX.

		Description
Model	F490	Loop Powered, Multi Purpose Indicator.
Input	A	4 - 20mA input.
Enclosures	HB	Aluminum panel mount enclosure.
	HC	GRP panel mount enclosure.
	HD	GRP field mount - Cable entry: no holes.
	HE	GRP field mount - Cable entry: 2 x Ø 16mm & 1 x Ø 20mm.
	HF	GRP field mount - Cable entry: 1 x Ø 22mm ($\frac{7}{8}$ ").
	HG	GRP field mount - Cable entry: 2 x Ø 20mm.
	HH	GRP field mount - Cable entry: 6 x Ø 12mm.
	HJ	GRP field mount - Cable entry: 3 x Ø 22mm ($\frac{7}{8}$ ").
	HK	GRP field mount, flat bottom - Cable entry: no holes.
	HA	Aluminum field mount - Cable entry: 2 x PG9 + 1 x M20.
	HL	Aluminum field mount - Cable entry: 2 x $\frac{1}{2}$ "NPT.
	HM	Aluminum field mount - Cable entry: 2 x M16 + 1 x M20.
	HN	Aluminum field mount - Cable entry: 1 x M20.
	HO	Aluminum field mount - Cable entry: 2 x M20.
	HP	Aluminum field mount - Cable entry: 6 x M12.
	HT	Aluminum field mount - Cable entry: 1 x $\frac{1}{2}$ "NPT.
	HU	Aluminum field mount - Cable entry: 3 x $\frac{1}{2}$ "NPT.
	HV	Aluminum field mount - Cable entry: 4 x M20.
	HZ	Aluminum field mount - Cable entry: no holes.
	HBM	Extended Alu. field/meter mount - Cable entry: 2 x M16 + 1 x M20 - req. XX.
	HBO	Extended Alu. field/meter mount - Cable entry: 2 x M20 - requires XX.
	HBU	Extended Alu. field/meter mount - Cable entry: 3 x $\frac{1}{2}$ "NPT - requires XX.
HSM	Stainless steel 316L field mount - Cable entry: 2 x M16 + 1 x M20 - req. XX.	
HSO	Stainless steel 316L field mount - Cable entry: 2 x M20 - requires XX.	
HSU	Stainless steel 316L field mount - Cable entry: 3 x $\frac{1}{2}$ "NPT - requires XX.	
Power	PL	Input loop powered from sensor signal type "A".
Hazardous	XI	Intrinsically safe, according ATEX, IECEx and CSA c-us.
	XX	Safe area only.
Options	ZB	Backlight.
	ZX	No options.

The **bold** marked text contains the standard configuration: F490-A-HC-PL-XX-ZX.