

**Screw-in/immersion temperature sensor with neck tube,
with passive output**
ETF 6
standard

Screw-in resistance thermometer / temperature sensor with neck tube
THERMASGARD® ETF 6 with passive output, with connecting head made from aluminium (optionally with **cable gland** or **M12 connector** according to DIN EN 61076-2-101) and straight protective tube.

The duct sensor is used to detect temperatures in liquid or gaseous media. It is used in pipes, tanks or storage systems, preferably where tubes or tanks must be isolated.

TECHNICAL DATA

Measuring range:	-35...+180 °C (T_{\max} NTC = +150 °C, T_{\max} LM235Z = +125 °C)
Sensors / output:	see table, passive (Perfect Sensor Protection) (optionally also with two or other sensors)
Connection type:	2-wire connection (4-wire connection on PT100, optional on other sensors)
Testing current:	< 0.6 mA (Pt1000) < 1.0 mA (Pt100) < 0.3 mA (Ni1000, Ni1000 TK5000) < 2.0 mW (NTC xx) 400 µA...5 mA (LM235Z)
Insulating resistance:	≥ 100 MΩ, at +20 °C (500 V DC)
Electrical connection:	0.14 - 2.5 mm ² , via terminal screws on ceramic base
Cable connection:	ETF 6 (standard) adjusting screw made of metal (M20 x 1,5) ETF 6-KV (optional) cable gland, brass, nickel-plated (M20 x 1.5; with strain relief, exchangeable, inner diameter 6 - 12 mm) ETF 6-Q (optional) M12 connector according to DIN EN 61076-2-101 (male, 5-pin, A-code)
Dimensions:	see dimensional drawing
Connecting head:	form B, material aluminium, colour white aluminium (similar RAL 9006), ambient temperature -20...+100 °C
Protective tube:	stainless steel V4A (1.4571), G ½" straight pipe thread, wrench size 27 mm, p_{\max} = 40 bar, Ø = 8 mm length of neck tube (HL) = 80 mm inserted length (EL) = 100 - 400 mm (see table)
Process connection:	screwed socket with G ½"
Humidity:	< 95% r. H., non-precipitating air
Protection class:	III (according to EN 60 730)
Protection type:	IP 54 (according to EN 60 529) ETF 6 IP 65 (according to EN 60 529) ETF 6-KV / ETF 6-Q



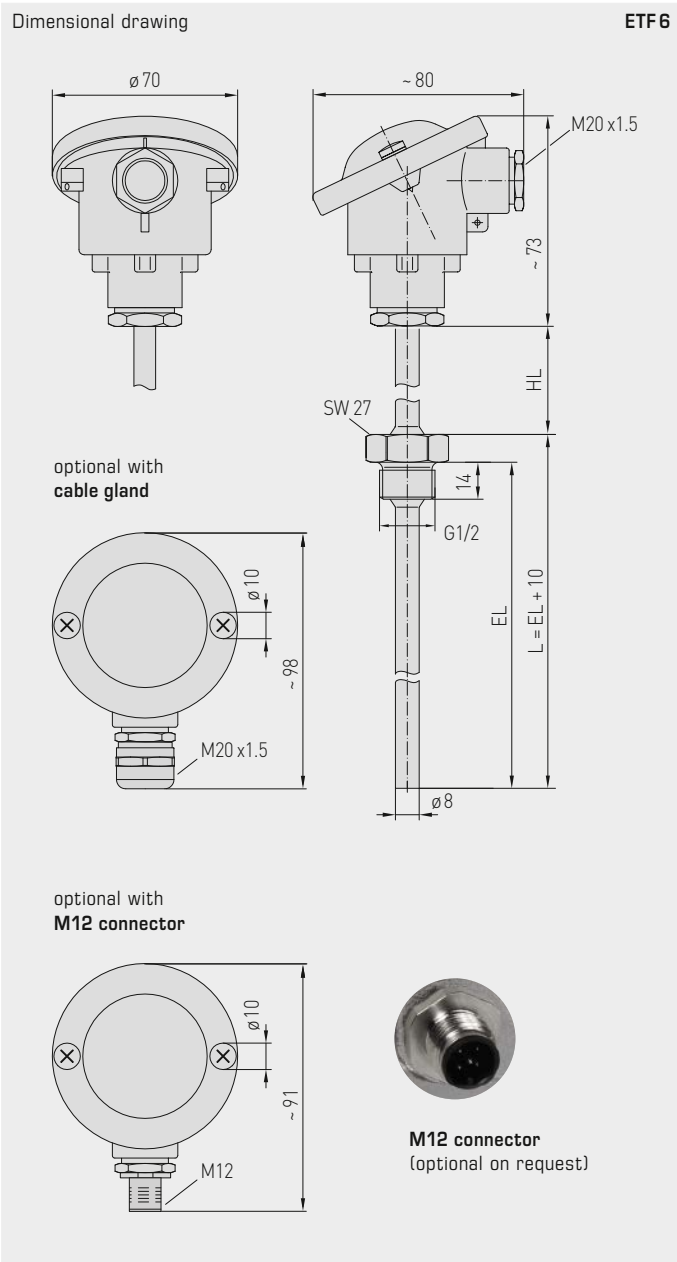

ETF 6
standard
(IP 54)



ETF 6 - KV
with cable gland
(IP 65)



ETF 6 - Q
with M12 connector
(IP 65)



High-performance encapsulation against vibration, mechanical stress and humidity



Screw-in/immersion temperature sensor with neck tube,
with passive output

ETF6
standard
(IP 54)

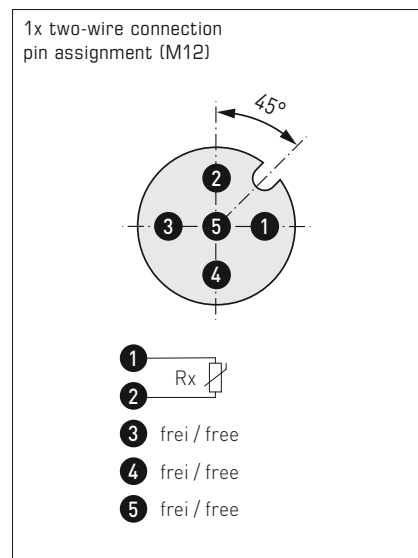
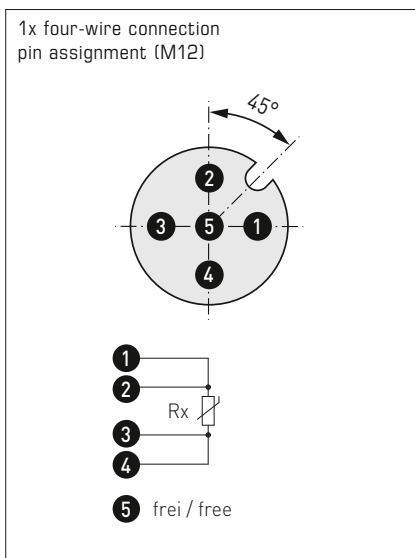
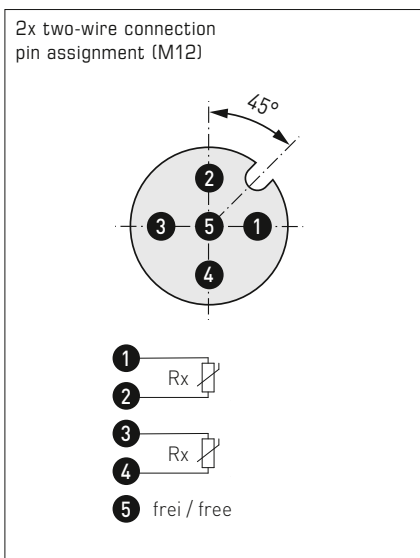
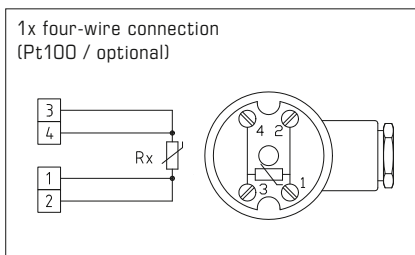
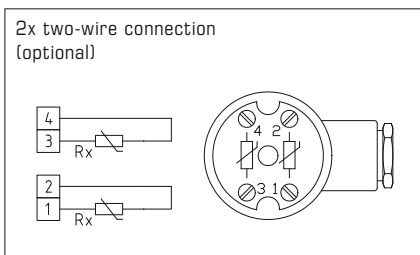
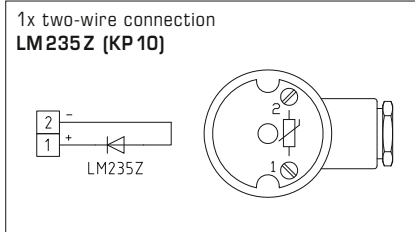
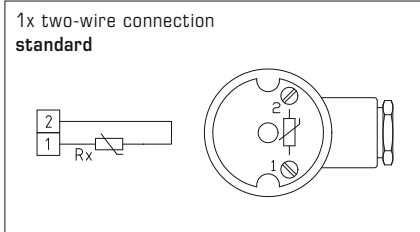

THERMASGARD® Screw-in / immersion temperature sensor with neck tube
ETF 6 (standard)

Type/WG03	Sensor/Output	Installation length (EL)	Item No.	Price
ETF6 Pt100 xx	Pt100 (according to DIN EN 60751, class B)		IP 54, 4-wire	
ETF6 Pt100 100/80	Pt100	100 mm	1101-2070-1023-000	73,21 €
ETF6 Pt100 150/80	Pt100	150 mm	1101-2070-1033-000	77,05 €
ETF6 Pt100 200/80	Pt100	200 mm	1101-2070-1043-000	79,24 €
ETF6 Pt100 250/80	Pt100	250 mm	1101-2070-1053-000	81,33 €
ETF6 Pt100 400/80	Pt100	400 mm	1101-2070-1083-000	83,88 €
ETF6 Pt1000 xx	Pt1000 (according to DIN EN 60751, class B)		IP 54, 2-wire	
ETF6 Pt1000 100/80	Pt1000	100 mm	1101-2070-5021-000	74,95 €
ETF6 Pt1000 150/80	Pt1000	150 mm	1101-2070-5031-000	79,24 €
ETF6 Pt1000 200/80	Pt1000	200 mm	1101-2070-5041-000	80,50 €
ETF6 Pt1000 250/80	Pt1000	250 mm	1101-2070-5051-000	81,45 €
ETF6 Pt1000 400/80	Pt1000	400 mm	1101-2070-5081-000	84,69 €

Continued on next page...



THERMASGARD® ETF 6		Screw-in / immersion temperature sensor with neck tube (standard)		
Type / WG03	Sensor / Output	Installation length (EL)	Item No.	Price
ETF6 Ni1000 xx	Ni1000 (according to DIN EN 43760, class B, TCR = 6180 ppm/K)		IP54, 2-wire	
ETF6 Ni1000 100/80	Ni1000	100 mm	1101-2070-9021-000	77,79 €
ETF6 Ni1000 150/80	Ni1000	150 mm	1101-2070-9031-000	79,18 €
ETF6 Ni1000 200/80	Ni1000	200 mm	1101-2070-9041-000	81,31 €
ETF6 Ni1000 250/80	Ni1000	250 mm	1101-2070-9051-000	81,74 €
ETF6 Ni1000 400/80	Ni1000	400 mm	1101-2070-9081-000	85,85 €
ETF6 Ni1000TK xx	Ni1000 TK5000 (TCR = 5000 ppm/K), LG-Ni1000		IP54, 2-wire	
ETF6 NiTK 100/80	Ni1000 TK5000	100 mm	1101-2071-0021-000	78,15 €
ETF6 NiTK 150/80	Ni1000 TK5000	150 mm	1101-2071-0031-000	79,98 €
ETF6 NiTK 200/80	Ni1000 TK5000	200 mm	1101-2071-0041-000	82,06 €
ETF6 NiTK 250/80	Ni1000 TK5000	250 mm	1101-2071-0051-000	84,58 €
ETF6 NiTK 400/80	Ni1000 TK5000	400 mm	1101-2071-0081-000	86,73 €
ETF6 LM235Z xx	LM235Z (TCR = 10mV/K; 2.73V at 0°C), KP10		IP54, 2-wire	
ETF6 LM235Z 100/80	LM235Z	100 mm	1101-2072-1021-000	74,30 €
ETF6 LM235Z 150/80	LM235Z	150 mm	1101-2072-1031-000	77,59 €
ETF6 LM235Z 200/80	LM235Z	200 mm	1101-2072-1041-000	79,24 €
ETF6 LM235Z 250/80	LM235Z	250 mm	1101-2072-1051-000	80,34 €
ETF6 LM235Z 400/80	LM235Z	400 mm	1101-2072-1081-000	85,41 €
ETF6 NTC 1,8K xx	NTC 1,8K		IP54, 2-wire	
ETF6 NTC1,8K 100/80	NTC 1,8K	100 mm	1101-2071-2021-000	77,92 €
ETF6 NTC1,8K 150/80	NTC 1,8K	150 mm	1101-2071-2031-000	79,09 €
ETF6 NTC1,8K 200/80	NTC 1,8K	200 mm	1101-2071-2041-000	80,29 €
ETF6 NTC1,8K 250/80	NTC 1,8K	250 mm	1101-2071-2051-000	83,75 €
ETF6 NTC1,8K 400/80	NTC 1,8K	400 mm	1101-2071-2081-000	86,12 €
ETF6 NTC10K xx	NTC 10K		IP54, 2-wire	
ETF6 NTC10K 100/80	NTC 10K	100 mm	1101-2071-5021-000	77,92 €
ETF6 NTC10K 150/80	NTC 10K	150 mm	1101-2071-5031-000	79,09 €
ETF6 NTC10K 200/80	NTC 10K	200 mm	1101-2071-5041-000	80,29 €
ETF6 NTC10K 250/80	NTC 10K	250 mm	1101-2071-5051-000	83,75 €
ETF6 NTC10K 400/80	NTC 10K	400 mm	1101-2071-5081-000	86,12 €
ETF6 NTC20K xx	NTC 20K		IP54, 2-wire	
ETF6 NTC20K 100/80	NTC 20K	100 mm	1101-2071-6021-000	77,92 €
ETF6 NTC20K 150/80	NTC 20K	150 mm	1101-2071-6031-000	79,09 €
ETF6 NTC20K 200/80	NTC 20K	200 mm	1101-2071-6041-000	80,29 €
ETF6 NTC20K 250/80	NTC 20K	250 mm	1101-2071-6051-000	83,75 €
ETF6 NTC20K 400/80	NTC 20K	400 mm	1101-2071-6081-000	86,12 €
Housing variant:	equipped as standard with pressure screw (IP54), optional housing variants with cable gland (IP65) or M12 connector (IP65) see the next page!			
Extra charge:	optionally also with two or other sensors			on request

Screw-in / immersion temperature sensor with neck tube,
with passive output

S+S REGELTECHNIK

ETF6-Q
with M12 connector
(IP 65)



THERMASGARD® ETF 6-Q		Screw-in / immersion temperature sensor with neck tube (with M12 connector)			
Type / WG03	Sensor / Output	Installation length (EL)	Q ●	Item No.	Price
ETF6 Pt100 xx Q		Pt100 (according to DIN EN 60751, class B)		IP 65, 4-wire	
ETF6 Pt100 100/80mm Q	Pt100	100 mm	●	2Z01-4121-0100-041	109,45 €
ETF6 Pt100 150/80mm Q	Pt100	150 mm	●	2Z01-4121-0100-051	113,29 €
ETF6 Pt100 200/80mm Q	Pt100	200 mm	●	2Z01-4121-0100-061	115,49 €
ETF6 Pt100 250/80mm Q	Pt100	250 mm	●	2Z01-4121-0100-071	117,58 €
ETF6 Pt100 400/80mm Q	Pt100	400 mm	●	2Z01-4121-0100-101	120,21 €
ETF6 Pt1000 xx Q		Pt1000 (according to DIN EN 60751, class B)		IP 65, 2-wire	
ETF6 Pt1000 100/80mm Q	Pt1000	100 mm	●	2Z05-4121-0100-041	109,45 €
ETF6 Pt1000 150/80mm Q	Pt1000	150 mm	●	2Z05-4121-0100-051	113,29 €
ETF6 Pt1000 200/80mm Q	Pt1000	200 mm	●	2Z05-4121-0100-061	115,49 €
ETF6 Pt1000 250/80mm Q	Pt1000	250 mm	●	2Z05-4121-0100-071	117,58 €
ETF6 Pt1000 400/80mm Q	Pt1000	400 mm	●	2Z05-4121-0100-101	120,12 €
Housing variant "Q":	Cable connection with M12 connector (male, 5-pin, A-code)				
Extra charge:	optionally also with two or other sensors			on request	

ACCESSORIES

Special accessories for M12 connector
see chapter Accessories!

ETF 6 - KV
with cable gland
(IP 65)**THERMASGARD®
ETF 6 - KV**Screw-in / immersion temperature sensor with neck tube
(with cable gland)

Type / WG03	Sensor / Output	Installation length (EL)	Item No.	Price
ETF6 Pt100 xx KV	Pt100 (according to DIN EN 60751, class B)		IP 65, 4-wire	
ETF6 Pt100 100/80mm KV	Pt100	100 mm	1101-20C0-1023-000	81,36 €
ETF6 Pt100 150/80mm KV	Pt100	150 mm	1101-20C0-1033-000	85,21 €
ETF6 Pt100 200/80mm KV	Pt100	200 mm	1101-20C0-1043-000	87,40 €
ETF6 Pt100 250/80mm KV	Pt100	250 mm	1101-20C0-1053-000	89,49 €
ETF6 Pt100 400/80mm KV	Pt100	400 mm	1101-20C0-1083-000	92,03 €
ETF6 Pt1000 xx KV	Pt1000 (according to DIN EN 60751, class B)		IP 65, 2-wire	
ETF6 Pt1000 100/80mm KV	Pt1000	100 mm	1101-20C0-5021-000	83,11 €
ETF6 Pt1000 150/80mm KV	Pt1000	150 mm	1101-20C0-5031-000	87,40 €
ETF6 Pt1000 200/80mm KV	Pt1000	200 mm	1101-20C0-5041-000	88,66 €
ETF6 Pt1000 250/80mm KV	Pt1000	250 mm	1101-20C0-5051-000	89,61 €
ETF6 Pt1000 400/80mm KV	Pt1000	400 mm	1101-20C0-5081-000	92,84 €
Housing variant "KV":	Cable connection with cable gland			
Extra charge:	optionally also with two or other sensors		on request	