

THERMASGARD® HTF50 THERMASGARD® HTF200

Huls / Kabeltemperatuursensor met passieve uitgang

S+S TEMP PASSIEF



HTF200
(NL = 200mm, incl. montageflens)
als kanaaltemperatuurvoeler



HTF50



MF-06-K

De THERMASGARD® HTF is geschikt voor het meten van temperaturen in vloeibare en gasvormige media, bijvoorbeeld door middel van inbouw in een dompelbuis of kanaal. Afhankelijk van het toepassingsgebied kan hij voorzien worden van siliconen-, glaszijde- of pvc-kabel. Leverbaar in de uitvoering twee- drie- en

vierdraads. De huls kan geleverd worden in lengten tussen 30...400 mm, standaard is 50 mm en 200 mm. De kabellengte is vrij te kiezen (standaard is 1,5 m). Bij gebruik in vloeistoffen adviseren wij dringend de dompelbuizen THE toe te passen.

TECHNISCHE DATA:

Meetbereik:.....	-35...105 °C PVC, LiYY, 2 x 0,25 mm ² -50...180 °C siliconen, SiHF, 2 x 0,25 mm ² -50...250 °C PTFE, 2 x 1,0 mm ² -50...350 °C glaszijde, 2 x 0,25 mm ² einden afgewerkt met adereindhulzen (optioneel grotere meetbereikgrenzen, dit is afhankelijk van het aansluitsnoer Tmax Ni1000 = 180 °C Tmax NTC / Ni1000 TK5000 = 150 °C Tmax LM235Z = 125 °C)
Sensoren / Uitgang:.....	zie tabel, passief (optioneel ook met twee sensoren)
Aansluitwijze:	2-draadsaansluiting (optioneel ook 4-draadsaansluiting)
Meetstroom:.....	< 0,6 mA (Pt100) < 1,0 mA (Pt1000) < 0,3 mA (Ni1000, Ni1000 TK5000) < 2,0 mW (NTC xx) 400 µA...5 mA (LM235Z)
Beschermbuis (voelerhuls):.....	RVS, 1.4571, V 4A, Ø = 6 mm HTF50 NL = 50 mm HTF200 NL = 200 mm (optioneel ook andere maten, NL = 30...500 mm)
Sensorkabel:.....	1,5 m (optioneel ook 3 m, 5 m, 8 m, 10 m)
Isolatieweerstand:.....	≥ 100 mΩ, bij 20 °C (500 VDC)
Procesaansluiting:	met een dompelbuis THE (zie tabel) of met een kunststofflens (optioneel staal verzinkt, zie accessoires)
Vochtigheid:.....	< 95% r.H. niet condenserende lucht
Beschermingsklasse:.....	III (volgens EN 60 730)
Beschermingsgraad:.....	IP65 (volgens EN 60529) vochtdicht geperst IP68 (optioneel waterdicht vergoten voelerhuls, met perfect sensor protection) IP 54 (optioneel aansluitleiding met glaszijde omvlochten)



IP65 standaard
vochtdicht geperst

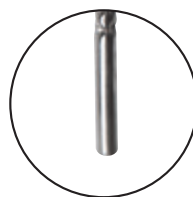

IP68 optioneel
waterdicht
vergoten, gerold

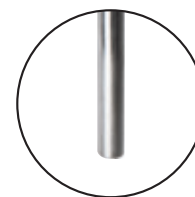

IP54 optioneel
met glaszijde kabel

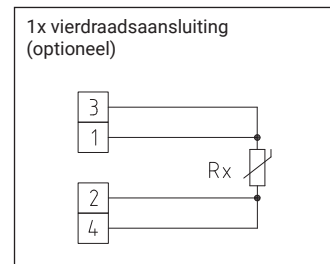
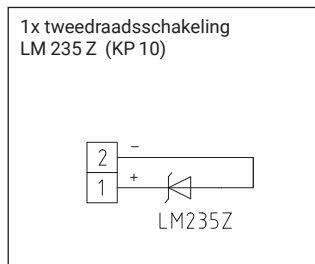
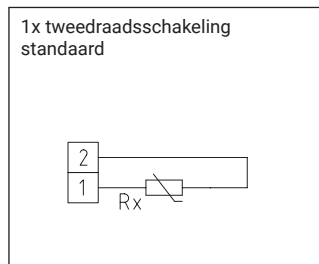

PS-PROTECTION

PERFECT SENSOR PROTECTION

High-Performance vergoten tegen vibratie mechanische belasting en vocht.



Afmetingen HTF

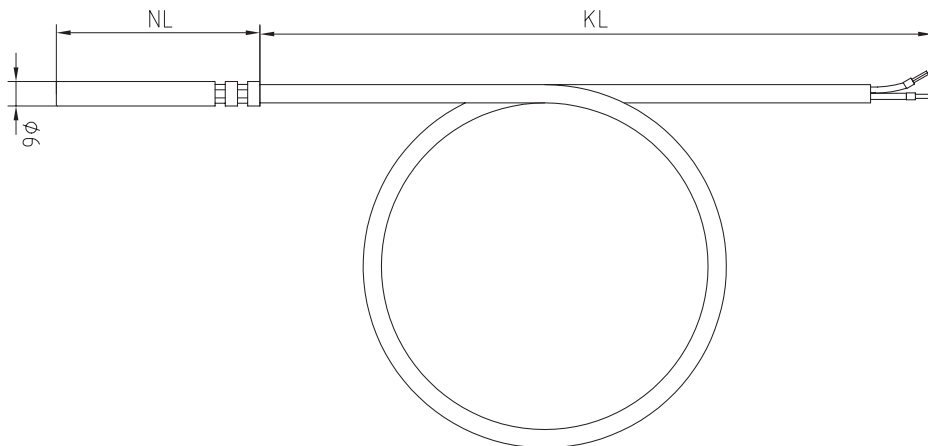

HTF50 met glaszijde



Afmetingen HTF50 + THE-VA

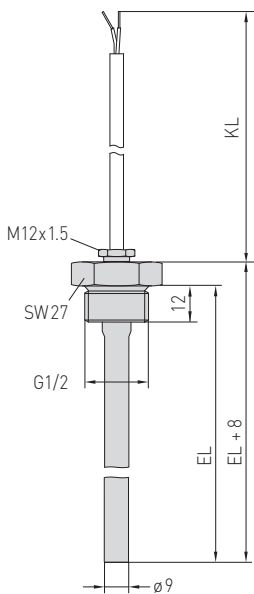

Afmetingen HTF50 + THE-MS

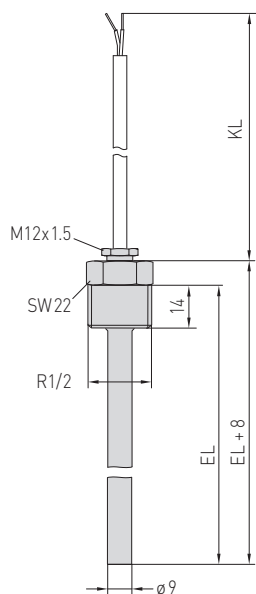

Afmetingen MF-06-K

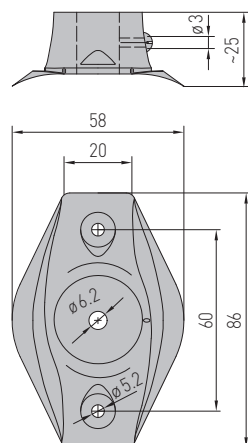

THERMASGARD® HTF50

Huls / Kabeltemperatuursensor met passieve uitgang

THERMASGARD® HTF50 (NL = 50mm)						
Type	Kabel-materiaal	Kabel-lengte	Meetbereik	Beschermings- graad	Productgroep	Artikelnummer
HTF50 PT100						
HTF50 PT100	PVC	1,5 m	-35...105 °C	IP65 *	3700	41007900
HTF50 PT100	siliconen	1,5 m	-50...180 °C	IP65 *	3700	41007910
HTF50 PT100	PTFE	1,5 m	-50...250 °C	IP65 *	3700	44017100
HTF50 PT100	glaszijde	1,5 m	-50...350 °C	IP54	3700	41007920
HTF50 PT100	PVC	3 m	-35...105 °C	IP65 *	3700	41007918
HTF50 PT100	siliconen	3 m	-50...180 °C	IP65 *	3700	41007911
HTF50 PT100	PVC	5 m	-35...105 °C	IP65 *	3700	41007919
HTF50_PT100	siliconen	5 m	-50...180 °C	IP65 *	3700	44017110
HTF50 PT100	PVC	8 m	-35...105 °C	IP65 *	3700	44017120
HTF50 PT100	siliconen	8 m	-50...180 °C	IP65 *	3700	44017130
HTF50 PT100	PVC	10 m	-35...105 °C	IP65 *	3700	44017170
HTF50 PT100	siliconen	10 m	-50...180 °C	IP65 *	3700	44017150
HTF50 PT1000						
HTF50 PT1000	PVC	1,5 m	-35...105 °C	IP65 *	3700	41007950
HTF50 PT1000	siliconen	1,5 m	-50...180 °C	IP65 *	3700	41007960
HTF50 PT1000	PTFE	1,5 m	-50...250 °C	IP65 *	3700	41007971
HTF50 PT1000	glaszijde	1,5 m	-50...350 °C	IP54	3700	41007970
HTF50 PT1000	PVC	3 m	-35...105 °C	IP65 *	3700	44017160
HTF50 PT1000	siliconen	3 m	-50...180 °C	IP65 *	3700	41007963
HTF50 PT1000	PVC	5 m	-35...105 °C	IP65 *	3700	41007954
HTF50 PT1000	siliconen	5 m	-50...180 °C	IP65 *	3700	41007985
HTF50 PT1000	PVC	8 m	-35...105 °C	IP65 *	3700	41007964
HTF50 PT1000	siliconen	8 m	-50...180 °C	IP65 *	3700	41007987
HTF50 PT1000	PVC	10 m	-35...105 °C	IP65 *	3700	44017170
HTF50 PT1000	siliconen	10 m	-50...180 °C	IP65 *	3700	41007988
HTF50 NI1000						
HTF50 NI1000	PVC	1,5 m	-35...105 °C	IP65 *	3700	41008000
HTF50 NI1000	siliconen	1,5 m	-50...180 °C	IP65 *	3700	41008010
HTF50 NI1000	PVC	3 m	-35...105 °C	IP65 *	3700	44017180
HTF50 NI1000	siliconen	3 m	-50...180 °C	IP65 *	3700	44017190
HTF50 NI1000	PVC	5 m	-35...105 °C	IP65 *	3700	44017200
HTF50 NI1000	siliconen	5 m	-50...180 °C	IP65 *	3700	44017210
HTF50 NI1000	PVC	8 m	-35...105 °C	IP65 *	3700	44008005
HTF50 NI1000	siliconen	8 m	-50...180 °C	IP65 *	3700	44017220
HTF50 NI1000	PVC	10 m	-35...105 °C	IP65 *	3700	44017230
HTF50 NI1000TK	siliconen	10 m	-50...180 °C	IP65 *	3700	44017240
HTF50 NI1000TK						
HTF50 NI1000TK	PVC	1,5 m	-35...105 °C	IP65 *	3700	41008050
HTF50 NI1000TK	siliconen	1,5 m	-50...180 °C	IP65 *	3700	41008060
HTF50 NI1000TK	PVC	3 m	-35...105 °C	IP65 *	3700	41008052
HTF50 NI1000TK	siliconen	3 m	-50...180 °C	IP65 *	3700	41008066
HTF50 NI1000TK	PVC	5 m	-35...105 °C	IP65 *	3700	41008058
HTF50 NI1000TK	siliconen	5 m	-50...180 °C	IP65 *	3700	41008085
HTF50 NI1000TK	PVC	8 m	-35...105 °C	IP65 *	3700	44017250
HTF50 NI1000TK	siliconen	8 m	-50...180 °C	IP65 *	3700	41008086
HTF50 NI1000TK	PVC	10 m	-35...105 °C	IP65 *	3700	41008070
HTF50 NI1000TK	siliconen	10 m	-50...180 °C	IP65 *	3700	44017260
HTF50 LM235Z						
HTF50 LM235Z	PVC	1,5 m	-35...105 °C	IP65 *	3700	41008200
HTF50 LM235Z	siliconen	1,5 m	-50...180 °C	IP65 *	3700	41008210
HTF50 LM235Z	PVC	3 m	-35...105 °C	IP65 *	3700	41008203
HTF50 LM235Z	siliconen	3 m	-50...180 °C	IP65 *	3700	44017270
HTF50 LM235Z	PVC	5 m	-35...105 °C	IP65 *	3700	44017280
HTF50 LM235Z	siliconen	5 m	-50...180 °C	IP65 *	3700	44017290
HTF50 LM235Z	PVC	8 m	-35...105 °C	IP65 *	3700	44017300
HTF50 LM235Z	siliconen	8 m	-50...180 °C	IP65 *	3700	44017310
HTF50 LM235Z	PVC	10 m	-35...105 °C	IP65 *	3700	44017320
HTF50 LM235Z	siliconen	10 m	-50...180 °C	IP65 *	3700	44017330

Vervolg op de volgende pagina



THERMASGARD® HTF50 (NL = 50mm)						
Type	Kabel- materiaal	Kabel- lengte	Meetbereik	Beschermings- graad	Productgroep	Artikelnummer
HTF50 NTC1,8K						
HTF50 NTC1,8K	PVC	1,5 m	-35...105 °C	IP65 *	3700	41008100
HTF50 NTC1,8K	siliconen	1,5 m	-50...180 °C	IP65 *	3700	41008110
HTF50 NTC1,8K	PVC	3 m	-35...105 °C	IP65 *	3700	44017340
HTF50 NTC1,8K	siliconen	3 m	-50...180 °C	IP65 *	3700	41008115
HTF50 NTC1,8K	PVC	5 m	-35...105 °C	IP65 *	3700	44017350
HTF50 NTC1,8K	siliconen	5 m	-50...180 °C	IP65 *	3700	44017360
HTF50 NTC1,8K	PVC	8 m	-35...105 °C	IP65 *	3700	44017370
HTF50 NTC1,8K	siliconen	8 m	-50...180 °C	IP65 *	3700	44017380
HTF50 NTC1,8K	PVC	10 m	-35...105 °C	IP65 *	3700	44017390
HTF50 NTC1,8K	siliconen	10 m	-50...180 °C	IP65 *	3700	44017400
HTF50 NTC10K						
HTF50 NTC10K	PVC	1,5 m	-35...105 °C	IP65 *	3700	41008150
HTF50 NTC10K	siliconen	1,5 m	-50...180 °C	IP65 *	3700	41008160
HTF50 NTC10K	PVC	3 m	-35...105 °C	IP65 *	3700	41008149
HTF50 NTC10K	siliconen	3 m	-50...180 °C	IP65 *	3700	41008179
HTF50 NTC10K	PVC	5 m	-35...105 °C	IP65 *	3700	41008170
HTF50 NTC10K	siliconen	5 m	-50...180 °C	IP65 *	3700	44017410
HTF50 NTC10K	PVC	8 m	-35...105 °C	IP65 *	3700	44017420
HTF50 NTC10K	siliconen	8 m	-50...180 °C	IP65 *	3700	44017430
HTF50 NTC10K	PVC	10 m	-35...105 °C	IP65 *	3700	44017440
HTF50 NTC10K	siliconen	10 m	-50...180 °C	IP65 *	3700	44017450
HTF50 NTC20K						
HTF50 NTC20K	PVC	1,5 m	-35...105 °C	IP65 *	3700	41008150
HTF50 NTC20K	siliconen	1,5 m	-50...180 °C	IP65 *	3700	41008161
HTF50 NTC20K	PVC	3 m	-35...105 °C	IP65 *	3700	44017460
HTF50 NTC20K	siliconen	3 m	-50...180 °C	IP65 *	3700	41008188
HTF50 NTC20K	PVC	5 m	-35...105 °C	IP65 *	3700	44017470
HTF50 NTC20K	siliconen	5 m	-50...180 °C	IP65 *	3700	44017480
HTF50 NTC20K	PVC	8 m	-35...105 °C	IP65 *	3700	44017490
HTF50 NTC20K	siliconen	8 m	-50...180 °C	IP65 *	3700	41008189
HTF50 NTC20K	PVC	10 m	-35...105 °C	IP65 *	3700	44017500
HTF50 NTC20K	siliconen	10 m	-50...180 °C	IP65 *	3700	44017510
Meerprijs:	* beschermingsgraad IP68 (sensorhuls waterdicht vergoten)					
	andere sensoren optioneel					
	kabel lengte (KL) 3 m, 5 m, 8 m, 10 m (standaardlengten)					
	aansluiting 4-draads (4-aderig)					

THERMASGARD® HTF200

Huls / Kabeltemperatuursensor met passieve uitgang

S+S TEMP PASSIEF

THERMASGARD® HTF200 (NL = 200mm)						
Type	Kabel-materiaal	Kabel-lengte	Meetbereik	Beschermingsgraad	Productgroep	Artikelnummer
HTF200 PT100						
HTF200 PT100	PVC	1,5 m	-35...105 °C	IP65 *	3700	41030000
HTF200 PT100	siliconen	1,5 m	-50...180 °C	IP65 *	3700	44017010
HTF200 PT1000						
HTF200 PT1000	PVC	1,5 m	-35...105 °C	IP65 *	3700	41030020
HTF200 PT1000	siliconen	1,5 m	-50...180 °C	IP65 *	3700	41030015
HTF200 PT1000 A						
HTF200 PT1000 A	PVC	1,5 m	-35...105 °C	IP65 *	3700	41030080
HTF200 PT1000 A	siliconen	1,5 m	-50...180 °C	IP65 *	3700	44017020
HTF200 NI1000						
HTF200 NI1000	PVC	1,5 m	-35...105 °C	IP65 *	3700	41007990
HTF200 NI1000	siliconen	1,5 m	-50...180 °C	IP65 *	3700	44017030
HTF200 NI1000TK						
HTF200 NI1000TK	PVC	1,5 m	-35...105 °C	IP65 *	3700	41007991
HTF200 NI1000TK	siliconen	1,5 m	-50...180 °C	IP65 *	3700	44017040
HTF200 LM235Z						
HTF200 LM235Z	PVC	1,5 m	-35...105 °C	IP65 *	3700	41030090
HTF200 LM235Z	siliconen	1,5 m	-50...180 °C	IP65 *	3700	44017050
HTF200 NTC1,8K						
HTF200 NTC1,8K	PVC	1,5 m	-35...105 °C	IP65 *	3700	41030100
HTF200 NTC1,8K	siliconen	1,5 m	-50...180 °C	IP65 *	3700	44017060
HTF200 NTC10K						
HTF200 NTC10K	PVC	1,5 m	-35...105 °C	IP65 *	3700	41007993
HTF200 NTC10K	siliconen	1,5 m	-50...180 °C	IP65 *	3700	44017070
HTF200 NTC20K						
HTF200 NTC20K	PVC	1,5 m	-35...105 °C	IP65 *	3700	41030070
HTF200 NTC20K	siliconen	1,5 m	-50...180 °C	IP65 *	3700	44017090
Meerprijs:	* beschermingsgraad IP 68 (sensorhuls waterdicht vergoten)					
	andere sensoren optioneel					
	kabel lengte (KL) 3 m, 5 m, 8 m, 10 m (standaard lengten)					
	aansluiting 4-draads (4-aderig)					



IP65 standaard
vocht dicht geperst



IP68 optioneel
waterdicht
vergoten, gerold

THERMASGARD® HTF50 THERMASGARD® HTF200

Huls / Kabeltemperatuursensor met passieve uitgang dompelbuizen



S+S TEMP PASSIEF

THERMASGARD® HTF50 en HTF200 accessoires

MF	Omschrijving	T _{max}	Productgroep	Artikelnummer
MF-06-K	montageflens kunststof (wordt niet meegeleverd)	100 °C	3700	44001235

THERMASGARD® HTF 50

Type	Omschrijving	Temp. T _{max}	Druk P _{max}	Lengte	Productgroep	Artikelnummer
THE-MS-50MM	dompelbuis	130 °C	16 bar	50 mm	3700	44018640
THE-MS-100MM	dompelbuis	130 °C	16 bar	100 mm	3700	44018650
THE-MS-150MM	dompelbuis	130 °C	16 bar	150 mm	3700	44018660
THE-MS-200MM	dompelbuis	130 °C	16 bar	200 mm	3700	44018670
THE-MS-250MM	dompelbuis	130 °C	16 bar	250 mm	3700	44018680
THE-VA-50MM	dompelbuis	200 °C	40 bar	50 mm	3700	44018410
THE-VA-100MM	dompelbuis	200 °C	40 bar	100 mm	3700	44018420
THE-VA-150MM	dompelbuis	200 °C	40 bar	150 mm	3700	44018430
THE-VA-200MM	dompelbuis	200 °C	40 bar	200 mm	3700	44018440
THE-VA-250MM	dompelbuis	200 °C	40 bar	250 mm	3700	44018450
THE-VA-300MM	dompelbuis	200 °C	40 bar	300 mm	3700	44018460
THE-VA-400MM	dompelbuis	200 °C	40 bar	400 mm	3700	44018470
xx = (EL)	andere lengtes op aanvraag					
voor verdere informatie zie laatste hoofdstuk S+S						