

Operating Manual



MEPS-S

● Content

1	Information	3
2	Overview	3
3	Signs, Abbreviations	3
4	Maintenance, Accessories	3
5	Storage, Disposal	3
6	Function	4
7	Safety Instructions	4
8	Before Mounting	4
9	Start-Up, Operation	4
9.1	Diaphragm Test	4
9.2	Product Label	5
9.3	Mounting	5
9.4	Adjusting the Display Unit	5
9.5	Zero Point Adjustment	5
9.6	Electrical Connection	6
9.7	Pin Assignment	6
9.8	Connection of Switching Outputs	7
9.9	Function Test	8
9.10	Error Detection / Fault Current	8
10	Configuration	9
10.1	System Operating Principles	9
10.2	Main Menu	11
10.3	Basic Menu	12
10.4	Display Menu	14
10.5	Switch Point Menu	15
10.6	Calibration Menu	17
10.7	System Menu	18
10.8	Menu Tree Overview	20
11	Troubleshooting	21
12	Technical Data	22

● 1 Information

Read these operating instructions without fail before installing and starting the pressure transmitter. Keep the operating instructions in a place that is accessible to all users at any time. The following installation and operating instructions have been compiled with great care but it is not feasible to take all possible applications into consideration. These installation and operation instructions should meet the needs of most pressure measurement applications. If questions remain regarding a specific application, please contact the supplier of the device.

With special models please note specifications in the delivery note.

If the serial number gets illegible (e. g. by mechanical damage), the retraceability of the instrument is not possible any more. The pressure sensors, described in this operating manual, are carefully designed and manufactured using state-of-the-art technology. Every component undergoes strict quality inspection in all stages of manufacture.

Use the products in accordance with the intended use

Use the pressure transmitter to transform the pressure into an electrical signal.

Knowledge required

Install and start the transmitter only if you are familiar with the relevant regulations and directives of your country and if you have the qualification required. You have to be acquainted with the rules and regulations on measurement and control technology and electric circuits, since this pressure sensor is "electrical equipment" as defined by EN 50178. Depending on the operation conditions of your application you have to have the corresponding knowledge, e.g. of corrosive media.

● 2 Overview

The most important information on the product and for your safety you can get in chapters *Signs, Abbreviations* (Chap. 3) and *Storage, Disposal* (Chap. 5), *Safety Instructions* (Chap. 7) and *Start-Up, Operation* (Chap. 9).
Read these chapters and comply.

● 3 Signs, Abbreviations



Warning!

Non-compliance can cause injuries to persons and/or can be a danger to life.



Attention!

Non-compliance can cause a faulty device operation or lead to property damage.



Information!

Non-compliance can have influence on device operation or cause unintentional device reactions.

U+: Positive supply connection
U-: Negative supply connection
SP1: Switching point 1
SP2: Switching point 2

● 4 Maintenance, Accessories



The pressure sensors MEPS-S are maintenance-free.
Only the manufacturer is allowed to perform repairs.
For necessary accessories please contact your supplier.

● 5 Storage, Disposal



When storing or disposing the pressure sensor, take precautions with regard to remaining media in removed pressure sensors. It's recommended to clean the transmitter properly and carefully. Remaining media in the pressure port may be hazardous or toxic.



Disposal

Dispose instrument components and packaging materials in accordance with the respective waste treatment and disposal regulations of the region or country to which the sensor is supplied

● 6 Function

The MEPS-S has a pressure connection with internal diaphragm. The pressure prevailing within the application is transformed into a standardised electrical signal through the deflection of the diaphragm, which acts on the sensor element with the power supply fed to the transmitter. This electric signal changes in proportion to the pressure and can be evaluated correspondingly.

● 7 Safety Instructions



Select the appropriate pressure sensor with regard to scale range, performance and specific measurement conditions prior to installing and starting the instrument.

Observe the relevant national regulations (e. g. standards) and observe the applicable standards and directives for special applications (e. g. with dangerous media such as acetylene, flammable gases or liquids and toxic gases or liquids and with refrigeration plants or compressors).

If you do not observe the appropriate regulations, serious injuries and/or damage can occur!

- **Open pressure connections only after the system is without pressure!**
 - Make sure that the pressure sensor is only used within the overload threshold limit all the time.
 - Observe the ambient and working conditions outlined in chapter "Technical data" (pages 22, 23).
 - Observe the technical data for the use of the pressure sensor in connection with aggressive / corrosive media and for the avoidance of mechanical hazards.
 - Ensure that the pressure sensor is only operated in accordance with the provisions i. e. as described in the following instructions.
 - Do not carry out changes or interferences with the pressure sensor which are not describes in these operating instructions.
 - Remove the pressure sensor from service and mark it to prevent it from being used again accidentally, if it becomes damaged or unsafe for operation.
 - **Take precautions with regard to remaining media in removed pressure sensors. Remaining media in the pressure sensor port may be hazardous or toxic!**
 - Have repairs performed by the manufacturer only.
 - Open circuit before removing connector / cover
-

● 8 Before Mounting



Check if a completely assembled pressure sensor is supplied.

Inspect the pressure sensor for possible damage during transportation. Should there be any obvious damage, inform the transport company and supplier without delay.

Keep the packaging, as it offers optimal protection during transportation.

Ensure that the pressure connection thread and the connection contacts will not be damaged.

● 9 Start-Up, Operation

9.1 Diaphragm Test

It is necessary to test the diaphragm before conducting start-up of the pressure transmitter. The diaphragm test is visual, as this is a **safety-relevant component**.



Pay attention to any liquid leaking out, for this points to diaphragm damage.

Use the pressure transmitter only if the diaphragm is undamaged.

Warning

Use the pressure transmitter only if it and its safety-relevant components is in faultless condition.

9 Start-Up, Operation (Continued)

9.2 Product Label (Example)

Logo	OP 0-0-0-3-0-0-08X	
Contact	SN : 774.04/10-4.0-001	Art.Nr.: 1500-00422
P : 0...20 bar	OUT : 4...20 mA HART	U+ : 1
Pmax : 0...25 bar	SUP. : 12...40 VDC	U- : 3
SP : 1xPNP	Date : 44/10	Made in Germany

OP... : Product code
Pmax : Range maximum
P : Pressure range
U+ : Supply/Loop +
U- : Supply/Loop -

Art.Nr.: Part number
SN : Serial number
Date : Date of QC
OUT : Loop signal
SUP. : Range of voltage

9.3 Mounting

Tools: wrench (flats 27), screw driver

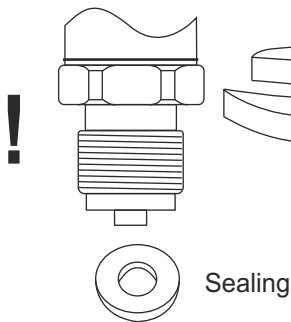

You have to provide for a sealing element, exceptions are instruments with self-sealing threads (e. g. NPT thread).

When mounting the instrument, ensure that the sealing faces of the instrument and the measuring point are clean and undamaged.

Screw in or unscrew the instrument only via the flats using a suitable tool and the prescribed torque. The appropriate torque depends on the dimension of the pressure connection and on the sealing element used (form/material). Do not use the case as working surface for screwing in or unscrewing the instrument.

When screwing the transmitter in, ensure that the threads are not jammed.

If necessary observe information about tapped holes and welding sockets.

9.4 Adjusting the Display Unit

It is possible to turn the display unit approx. 300° to optimize the reading. To do so, hold the plastic body with one hand and turn the display unit with the other hand into the wanted position.

The turning angle is limited by an internal limit stop. Do not try to force the display beyond that point. It might be destroyed.

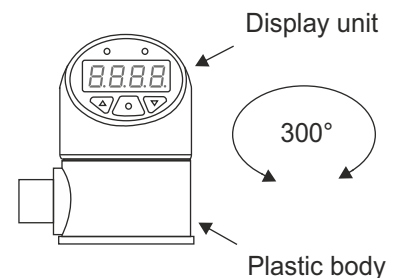

9.5 Zero Point Adjustment

When putting the device into operation, check the zero point indicated on the display. If, due to the mounting, an offset is displayed, a reset can be made in configuration mode using the item „teach lower range“ (tLr) within the calibration menu.



For relative or vacuum pressure ranges, make sure that the device is depressurized before carrying out a zero point adjustment.

For absolute pressure measuring ranges, the zero point adjustment must be carried out in a vacuum. This means at 0 bar absolute. Due to the fact that special references are required for this, it is recommended to have this work carried out by the manufacturer.

9 Start-Up, Operation (Continued)

9.6 Electrical Connection

Connect the instrument to earth via the pressure connection.



The ingress protection specified only apply while the pressure transmitter is connected with the female connectors that provide the corresponding ingress protection.

Ensure that the cable diameter you select fits to the cable gland of the connector. Ensure that the cable gland of the mounted connector is positioned correctly and that the sealings are available and undamaged. Tighten the threaded connection and check the correct position of the sealings to ensure ingress protection.

Make sure that the ends of cables with flying leads do not allow any ingress of moisture.

Route the cable without applying a force or turning moment to the device.

9.7 Pin Assignment

Connection	Current loop 4...20 mA HART		Limit value contact		
	U+	U-	Common	SP 1	SP 2
M12, 4-pole	1	3	2	4	
M12, 5-pole	1	3	5	4	2
M12, 8-pole	1	3	5	4	2
Super Seal, 3-pole	1	3			
Deutsch DT04, 3-pole	A	B			
Deutsch DT04, 4-pole	1	3	2	4	
Bayonet DIN, 4-pole	1	2	3	4	
Valve (L-plug), 4-pole	1	2	3	GND	
Cable, 4-pole	yellow	white	green	brown	
Cable, 6-pole	yellow	white	green	brown	grey
MIL, 6-pole	A	C	E	D	B

View: plug pins of male connector

M12, 4-pole	M12, 5-pole	M12, 8-pole	Super Seal, 3-pole	Deutsch DT04, 3-pole
Deutsch DT04, 4-pole	Bayonet DIN, 4-pole	Valve (L-plug), 4-pole	MIL, 6-pole	Cable, 4-, 6-pole
				LIYCY 4 or 6x0,25 mm ² grey

● 9 Start-Up, Operation (Continued)

9.8 Connection of Switching Outputs

The switching outputs are potential-free. They are electrically isolated from the current loop (see right).

In case of using only one switching point it is possible to connect the load on both sides of the contact, e.g. NPN-style: load connected to high or low side (see below).

Use an appropriate recovery diode if you want to switch inductive loads.

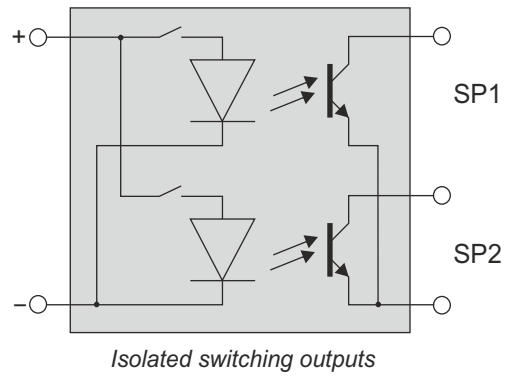

Switching outputs with common on low side (NPN)

Two outputs are used	One output is used, load on high side	One output is used, load on low side

Switching outputs with common on high side (PNP)

Two outputs are used	One output is used, load on high side	One output is used, load on low side

9 Start-Up, Operation (Continued)

9.9 Function Test



The output signal must be proportional to the pressure. If not, this might point to a damage of the diaphragm. In that case refer to chapter *Troubleshooting* (page 21).



Warning

- Open pressure connections only after the system is without pressure.
- Observe the ambient and working conditions outlined in chapter *Technical Data* (page 22)
- Please make sure that the pressure transmitter is only used within the overload threshold limit at all times. (table page 23)
- When touching the transmitter, keep in mind that the surfaces of the instrument components might get hot during operation.

9.10 Error Detection / Fault Current

The device detects wire break and short circuit (sensor element <> measuring amplifier) as well as pressures outside of the measuring range and indicates this with an error current in the current loop circuit.

The current output is proportional to the pressure from 3,8 to 20,5 mA. If the measured pressure would result in a current below 3,8 mA the current output is set to 3,6 mA (also for a wire short circuit). If the current would exceed 20,5 mA, the current output is set to 21 mA (also for wire break).

If the device is equipped with switching outputs, these will be disabled if an error is detected for more than 10 seconds. This ensures that the switches are in a safe state, comparable to the of voltage supply.

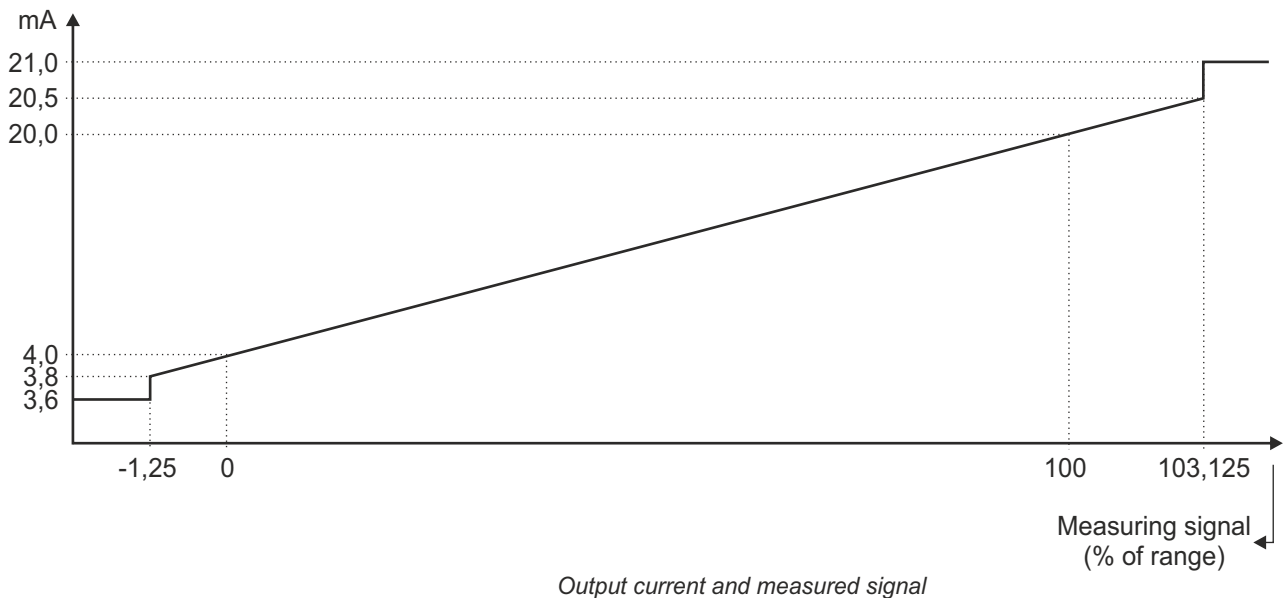

● 10 Configuration

Description of handling and configuration of the display device.

An overview of the menu tree is shown on page 23.

The 3 buttons on the display head operate by capacitive principle with no mechanical components: When pressing a button, there is no key drop. The buttons are reacting to the approach of a finger via sensing its electromagnetic field. Withdraw your finger at least 1 cm after pressing a button. This is useful for proper keypress detection.

The following description is for a device configuration using capacitive buttons. The configuration via HART communication modem is described in a separate manual.

10.1 System Operating Principles

10.1.1 System feedback to operator when buttons are pressed

The LEDs for switching output are used to give a feedback to operator when buttons are pressed. This does not affect the switching outputs themselves. When no button is pressed the LEDs are showing the state of switching outputs.

Button		Feedback
	Arrow button down (left)	Left LED is flashing
	Arrow button up (right)	Right LED is flashing
	Both arrow buttons simultaneously	Both LEDs are flashing
	Center button	Both LEDs are flashing rapidly

Feedback of the buttons

10.1.2 Display mode / Measured value indication

After power up the device starts in display mode. The current measured value is displayed or is displayed alternately with the unit (see 10.4.1).

The displayed value is flashing when the measured value is greater than the maximal presentable value. This can be caused by a fixed decimal point (see 10.4.3).

As long as the center button is pressed the selected unit will be displayed.

A single arrow button has no function in display mode.

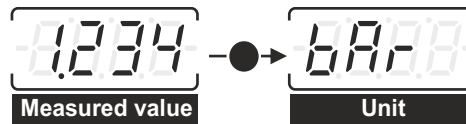

Indication of unit

10.1.3 Activating the configuration mode

When pressing both arrow keys simultaneously for at least 2 s the configuration mode is entered. The first entry of the operator menu appears on the display (bA5E). If both buttons are not released within 4 s the device switches back to display mode, showing the current measured value again.

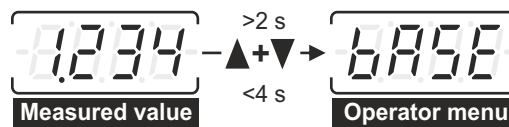

Activating the configuration mode

10 Configuration (Continued)

10.1.4 Configuration mode / Operator menu

The configuration mode always starts with the first item of the main menu (bASE). Within the menu you navigate with the arrow buttons. The center button selects a menu item respectively enters a submenu. Menu items which just show a value (e.g. maximum pointer) can be exit to the next upper menu item with the center button.

Every menu has the item „-ret-“ (return) which allows you to go back to the next upper menu. In the main menu it goes back to the display mode.

At the end of a menu (typically „-ret-“) you return to the first menu item when pressing the down arrow button again. Similarly, you jump to the end of the menu when pressing the up arrow in the first menu item.

In each menu item it is possible to return to the next upper menu by pressing both arrow buttons simultaneously. The feedback is a flashing „-ret-“. When doing this for more than 1 s, the device returns to display mode with the feedback of a flashing „-ESc-“ (escape).

If no button is pressed for 5 minutes in the configuration mode, the device automatically switches back to the display mode.

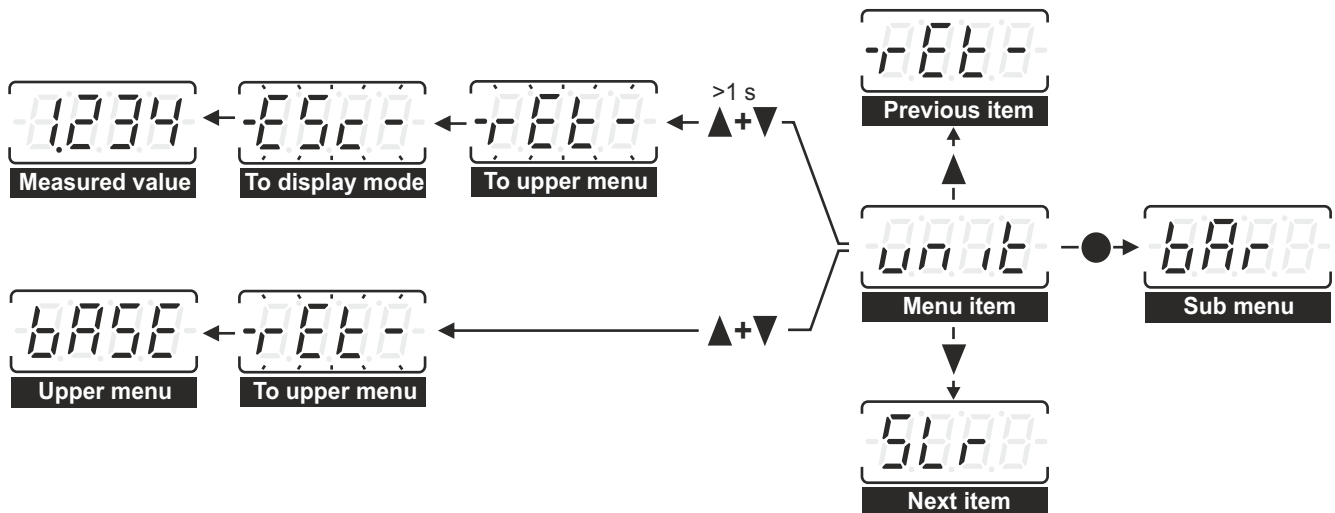

Configuration mode: Example operator menu

10.1.5 Setting values

There are 2 types of values that can be altered:

- values which can be selected from a predefined parameter list
- numerical values

Selecting a value from a list

Parameter lists are used for example for the units. Within the list you navigate with the arrow buttons. With the center button a selected value is stored, confirmed with indicating „Stor“. After that the device is in the next upper menu.

The list can be left by pressing both arrow buttons simultaneously to the next upper menu without changing the present value.

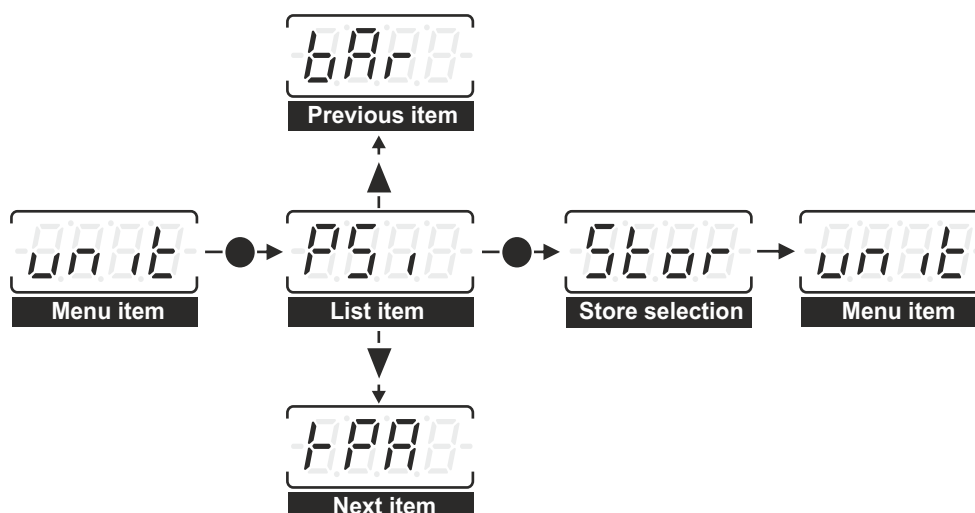

Configuration mode: Example to select a value from a list

● 10 Configuration (Continued)

Setting a numerical value

Numerical values are entered digit by digit. The selected digit flashes and is incremented with the up arrow button and decremented with the down arrow button. The more significant digit will also be incremented or decremented when stepping over zero. If a change of the active digit would exceed the allowable value (e.g. the lower or upper range limit) the allowable value will be shown. With the opposite arrow button you can return to the previous value.

The selected digit is confirmed with the center button and proceed to the next digit. You can cancel the value entry at any time by pressing both arrow buttons simultaneously. The device will then switch back to the corresponding menu entry. The partially edited value will not be saved.

When the right-most digit is selected, the center button confirms the whole value. "Stor" appears on the display to confirm that the value has been stored and the device switches back to the menu item for the value.

You can store a partially edited value at any digit position by holding the center button until "Stor" appears on the display (approx. 2 s).

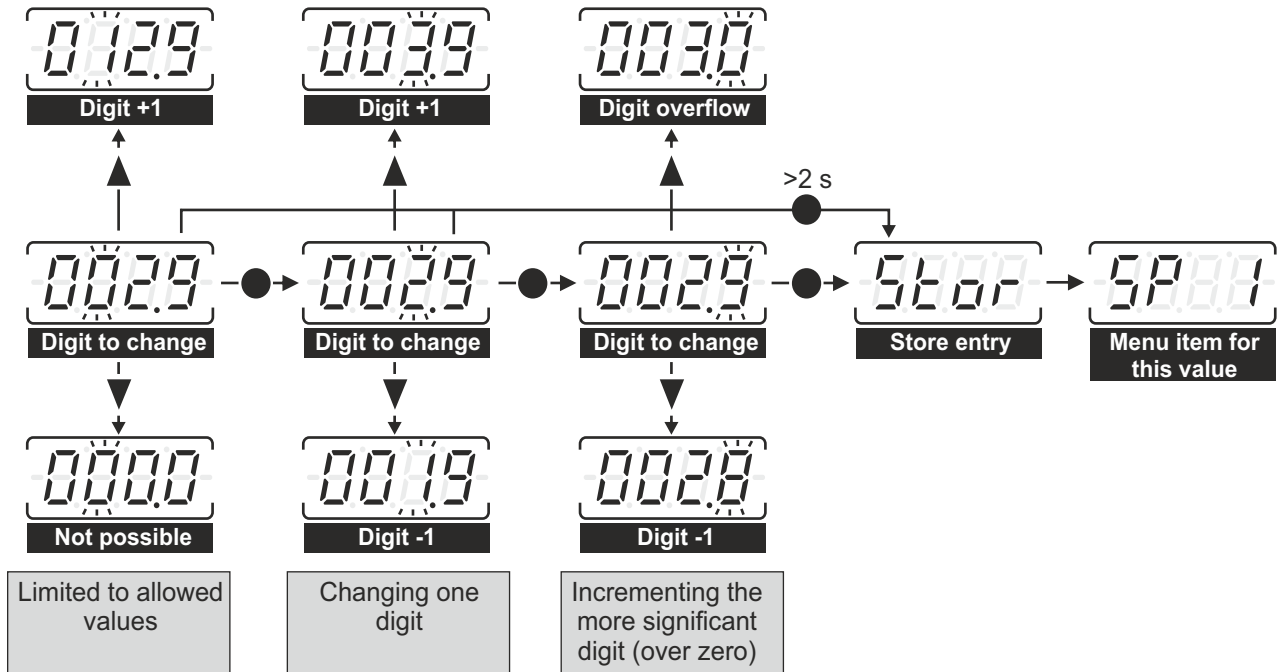

Button functions for entering numerical values (Example)

10.2 Main Menu

The main menu has the following functions

Display	Designation	Description
6A5E	Basic functions	Setting of unit, lower and upper range value, minimum and maximum pointer
815A	Display functions	All settings relating to the display
85A8	Switch point settings	Configuration of the switching outputs (option)
0A18	Calibration functions	Teaching lower and upper ranges, calibrating the current output
9998	System data	Reset to factory settings, loop test, Displaying of: hardware version, software version, serial number
8E18	Return	Return to display mode

● 10 Configuration (Continued)

10.3 Basic Menu (bASE)

The basic menu has the following functions

Display	Designation	Description
	Measuring unit	Setting the measuring unit (parameter list)
	Set lower range	Setting the pressure corresponding to 4 mA current signal
	Set upper range	Setting the pressure corresponding to 20 mA current signal
	Set damping	Setting the damping for the pressure signal
	Trailing pointer minimum (low)	Display and/or delete the minimum trailing pointer
	Trailing pointer maximum (high)	Display and/or delete the maximum trailing pointer
	Return	Return to main menu

10.3.1 Setting the Measuring Unit (unit)

A selected unit applies to data entries (e.g. switching points) and to the displaying of numerical values (e.g. the trailing pointers). Possible are the following units:

Display	Unit	Display	Unit
	mbar		MPa
	bar		% of measuring range
	PSI		mA
	kPa		Return to „Unit“

Example for the needed steps for changing the unit from psi to bar:

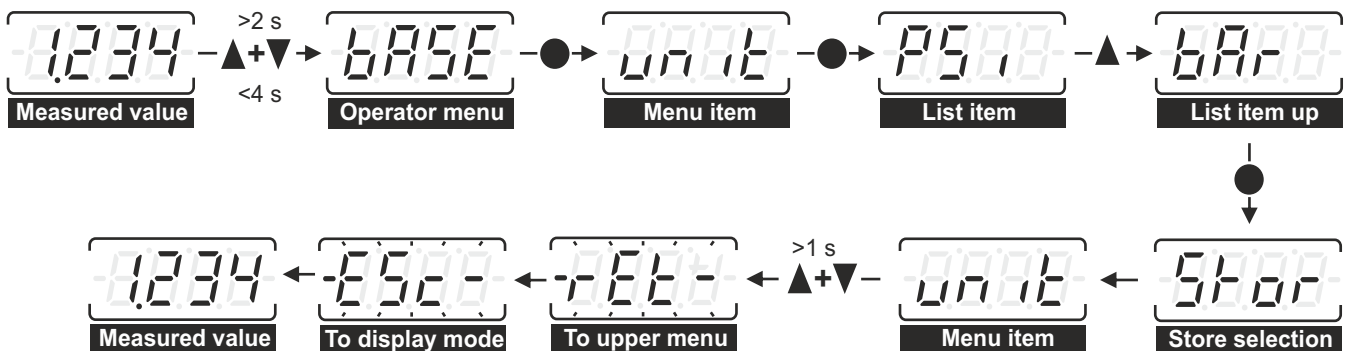

Steps to change the unit

● 10 Configuration (Continued)

10.3.2 Setting lower and upper ranges (SLr / Sur)

It is possible to set the lower range (SLr) and the upper range (Sur) value as needed within the allowed pressure range of the device (lower and upper range limit), which is also known as „turn down“. Make sure that there are no settings outside the permitted pressure range.

Select the desired menu item and then enter the pressure which has to correspond to 4 mA (SLr) or 20 mA (Sur) loop current. This will not affect the calibration of the transmitter and the current output.

A changing of the measuring range will delete the trailing pointers automatically.

This function is only available with the units mbar, bar, psi, kPa, MPa.

Note: Although the switch points are set in the chosen unit, they are saved as a percentage of the range. Therefore the absolute switch point pressure will change with every new setting of the range. So it is always necessary to check the settings of the switch points after the setting of new range values.

10.3.4 Setting the damping (dAP)

The damping of the pressure can be set in intervals of 0.1 s. Damping is disabled with the setting 0.0 s. The default setting is 0.1 s.

The damping impacts current output and switch points equally.

10.3.4 Trailing pointers (Lo / Hi)

The trailing pointers for minimum and maximum values can be displayed or reset. A reset is confirmed with „----“ on the display.

The trailing pointer shows „Er.Lo“ respectively „Er.Hi“ if the current output has been set to a fault current (see 9.10).

Display	Designation	Description
	Value of min/max pointer	Value of the min/max pointer in the selected measuring unit
	Clear	Reset the stored pointer value
	Return	Return to „Lo“ or „Hi“

The steps to reset the minimum pointer are shown below.

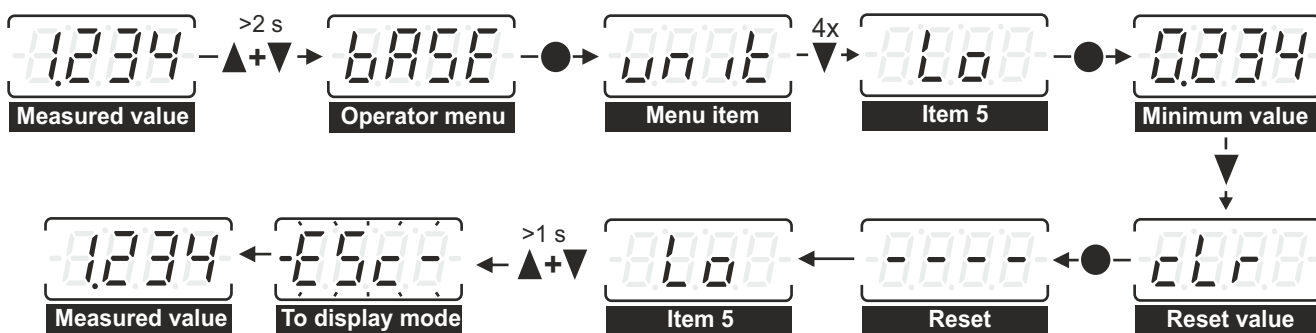

Steps to reset the minimum pointer

● 10 Configuration (Continued)

10.4 Display Menu (diSP)

The display menu has the following functions

Display	Designation	Description
	Add unit	Adds the unit to the pressure on the display or removes it
	Display period for measured value (time data)	Setting between 0,5...99,9 s possible
	Display period for unit (time unit)	Setting between 0,0...99,9 s possible
	Rotate 180°	Rotate screen by 180° when the device is mounted upside down
	Decimal places	Setting the decimal places (0...3 fixed decimal places or automatic)
	Return	Return to „diSP“

10.4.1 Display option for measuring unit (AddU)

You can set the display to show pressure and unit simultaneously. When „on“ is selected, the menu items „td“ (display period for pressure and „tu“ (display period for unit) are hidden (see 10.4.2).

Display	Designation	Description
	Off	The unit will be displayed alternately with pressure
	On	Unit and pressure will be displayed simultaneously
	Return	Return to „AddU“

10.4.2 Display period for measured value/unit (td / tu)

The unit can be shown either by pressing the center button in display mode or alternately with the measured value. The display periods of measured value and unit can be configured independently of one another.

Setting the period for the unit to 0.0, only the measured value will be displayed.

10.4.3 Rotating the display by 180° (rot)







In case of mounting the device upside down, the 7-segment display and buttons can be rotated by 180° so that reading and operating are possible as is usual.

Display	Designation	Description
	Standard (0°)	
	Upside down (180°)	Display rotated by 180° for upside down operation
	Return	Return to „rot“

● 10 Configuration (Continued)

10.4.4 Decimal point setting (dEcP)

Possible is a fixed or an automatic positioning of the decimal point.







Display	Designation	Description
	Automatic	The decimal point is set so that all digits are fully used
	No decimal place	
	One decimal place	
	Two decimal places	
	Three decimal places	
	Return	Return to „dEcP“

Please note that when the decimal point is fixed the measured value may not be displayed if there are insufficient digits left of the decimal point. In this case the maximum number that can be shown on the display will appear flashing, e.g. "99.99", when two decimal places are set for a measured value of 110 °C.

If the "Add unit" function is enabled (see 10.4.1), the parameter list will be modified to reflect the available options for displaying measured value and unit simultaneously.

10.5 Switch Point Menu (SP)

The menu has items for the settings of the two switch points. The output behaviour can be a hysteresis or a frame function where the menu items are different. The switching delays can be defined independently from the output

Display	Designation	Description
	Switch point	Switch point in the selected measuring unit
	Reset point	Reset point in the selected unit
	Delay switch	Output delay at switch point
	Delay reset	Output delay at reset point
	Output function	Configuring the output behaviour (normally open, normally close, hysteresis / frame function)
Menu items for switch point 2		
	Return	Return to „SP“

● 10 Configuration (Continued)

The switch point (SP) must be between the upper range value (URV) and the reset point. The reset point (rP) must be between the lower range value (LRV) and the switch point. The minimum hysteresis (difference between switch point and reset point) is 0,5% of the measuring range (MR) which is configured under 10.3.2.

It is possible to define a delay for the switch point as well as the reset point, e.g. to avoid that short pressure peaks trigger the switch.

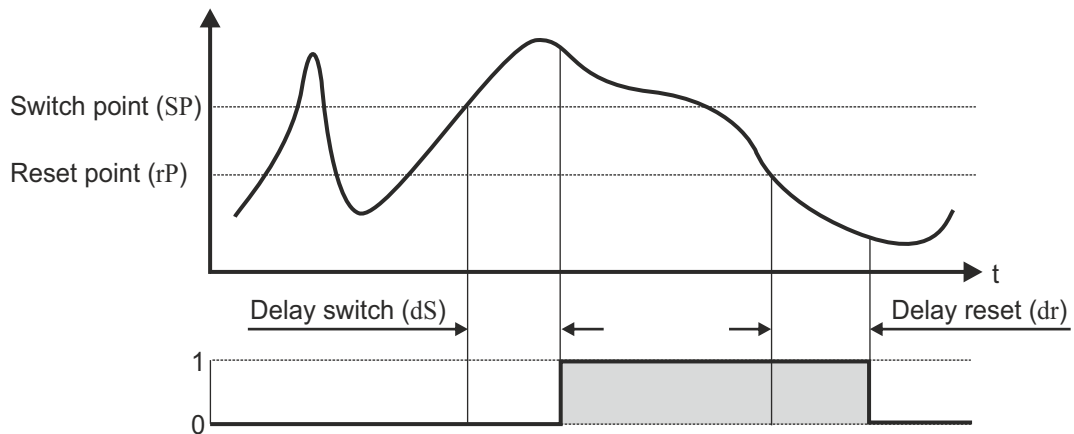
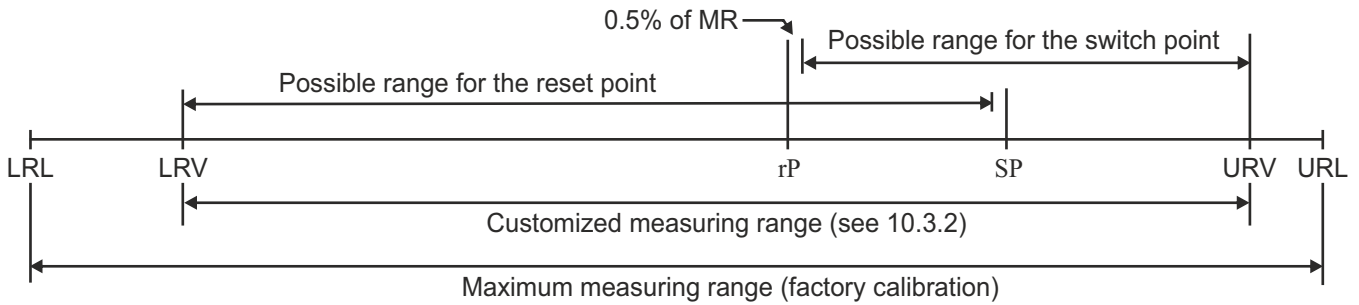

When the frame function is used, the menu items for switch point and reset point are replaced by the upper and lower frame limits. The minimum difference of the frame limits is 0,5% of the measuring range (MR) which is configured under 10.3.2.

Display	Designation	Description
	Frame high	Upper frame limit in the selected measuring unit
	Frame low	Lower frame limit in the selected measuring unit
	Delay switch	Output delay when entering the frame
	Delay reset	Output delay when leaving the frame
	Output function	Configuring the output behaviour (normally open, normally close, hysteresis / frame function)
Menu items for switch point 2		
	Return	Return to „SP“

● 10 Configuration (Continued)

10.5.1 Configuring the output function (out 1 / 2)

Possible are hysteresis or frame functions and the output as normally open or closed contacts .

Display	Designation	Description
	Hysteresis, normally open	If the pressure is above the switch point the switch is closed. At the lower range limit the switch is open.
	Hysteresis, normally closed	If the pressure is above the switch point the switch is open. At the lower range limit the switch is closed.
	Frame, normally open	Inside of the frame the switch is closed. At the lower range limit the switch is open.
	Frame, normally closed	Inside of the frame the switch is open. At the lower range limit the switch is closed.
	Return	Return to „out 1" or „out 2"

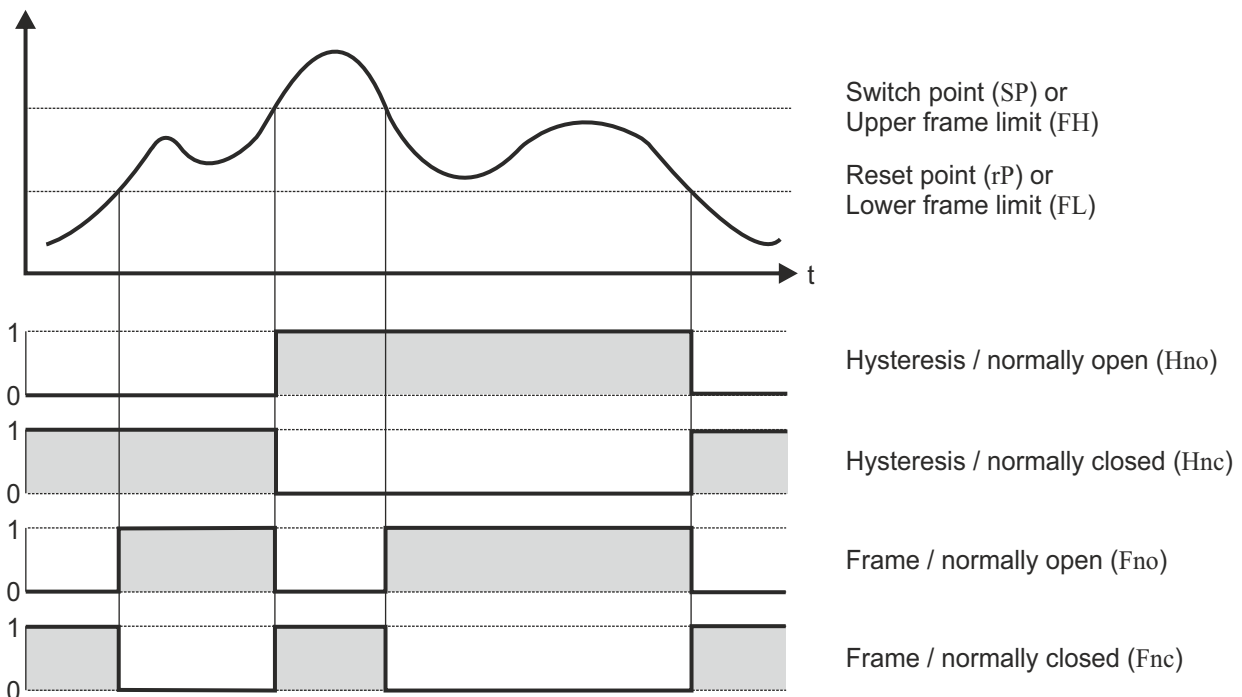

10.6 Calibration Menu (CAL)

The calibration menu has the following functions

Display	Designation	Description
	Teach lower range	Adjust the lower range (4 mA) to the applied pressure
	Teach upper range	Adjust the upper range (20 mA) to the applied pressure
	Adjust 4 mA	Adjust the current output at 4 mA
	Adjust 20 mA	Adjust the current output at 20 mA
	Return	Return to „CAL"

● 10 Configuration (Continued)



10.6.1 Adjusting lower and upper range (tLr / tur)

It is possible to adjust the output current for the lower range value (LRV) and the upper range value (URV) under the menu items „tLr“ and „tur“ to a certain pressure.

For the adjustment a stable pressure according the settings in chapter 10.3.2 has to be applied, e.g. by using a pressure balance. Then enter the calibration menu and select „tLr“ respectively „tur“. When entering the menu the entry points to „rEt“. To confirm the applied pressure go to „YES“ with one of the arrow buttons and press the center button. After this final confirmation the applied pressure will be matched to the lower or upper range value.

Example: In chapter 10.3.2 the lower range value was set to 1.00 bar. Now apply 1.00 bar with a pressure balance. When the display reading is stable go to the menu item „Teach Lower Range“ and confirm with „YES“. From now on the transmitter will regard the actual sensor element reading as 1.00 bar. The internal calculation of the pressure value out of the measured value will be adapted accordingly.

When confirming with the center button „donE“ appears on the display which confirms that the device has acknowledged the change. Then the device switches back to the initial menu item („tLr“ or „tur“).

Display	Designation	Description
	Return	Return to „tLr“ or „tur“
	Yes	Adjust the lower or upper range value to the applied pressure

10.6.2 Adjusting the current output (4 mA / 20 mA)

It is possible to adjust the output current to eliminate tolerances and systemic deviations in the output driver or subsequent devices in the current loop.

Below are the steps for the lower current limit (4 mA). The adjusting of the upper current limit (20 mA) is done similar.





Select the menu item „4 mA“ and the device sets the output current to 4 mA. The display shows „04.00“. Now check the reading on the remote measuring instrument. If it deviates from 4 mA, enter this value in the device.

Example: The remote instrument shows 4.02 mA due to tolerances in the current loop. Enter then „04.02“ at the device.

If the value is confirmed the device will adjust the current output so that the remote instrument now will show 4.00 mA. The device will hold the 4 mA current output for 3 seconds so that it's possible to check the reading of the remote instrument. During this time the display will show „Stor“. After that period the device will calculate the current output depending on the measured pressure and switch back to the menu item „4 mA“.

10.7 System Menu (SYS)

The system menu has the following functions

Display	Designation	Description
	Loop test	Setting a fixed current in order to test the current loop
	Information	Indicating of hardware and software version, serial number
	Reset	Reset to factory settings
	Return	Return to „SYS“

● 10 Configuration (Continued)







10.7.1 Loop test (LoOP)

The device can be used to test the current loop. For this the current output can be set to any value between 3.6...21 mA. When an entry is confirmed, the transmitter sets the output current to the selected value and displays this value flashing. The flashing shows that the displayed value is not a valid measurement.

Note: In this mode the device will not return to the display mode after 5 minutes but continue the test until the operator will stop it by pressing the center button or both arrow buttons. The device returns to the menu item „LoOP“ and the output current returns to the value which is corresponding to the measured pressure.

10.7.2 Information (inFo)

The information menu has the following functions



Display	Designation	Display	Designation
	Hardware version 1 (HW1)		Software version 2 (SW2)
	Hardware version 2 (HW2)		Serial number 1 (Sn 1)
	Software version 1 (SW1)		Serial number 2 (Sn 2)
	Return	Return to „InFo“	

Due to the limited number of alphanumerical segments on the display the values for these items are split.

10.7.3 Reset to factory settings (rES)

It is possible to reset the device to the configuration as delivered with the menu item „Reset“ (rES). When entering the menu the entry points to „rEt“. To confirm the reset go to „YES“ with one of the arrow buttons and press the center button. After this final confirmation all parameters will be changed to the settings as delivered.

When confirming with the center button „donE“ appears on the display which confirms that the device has been reset to factory settings. Then the device switches back to the initial menu item („rES“).

Display	Designation	Description
	Return	Return to „rES“
	Yes	Resetting the device to factory settings

10.8 Menu Tree Overview

BASE		Menu with basic functions
	unit	Setting the measuring unit (mbar, bar, psi, kPa, MPa, %, mA)
	SLr	Setting the pressure (LRV) that corresponds to 4 mA output signal (only for mbar, bar, psi, kPa, MPa)
	Sur	Setting the pressure (URV) that corresponds to 20 mA output signal (only for mbar, bar, psi, kPa, MPa)
	dAP	Setting the damping for the pressure signal
	Lo	Display and/or delete the minimum trailing pointer
	Hi	Display and/or delete the maximum trailing pointer
dISP		All settings relating to the display
	AddU	Enable or disable displaying unit and pressure simultaneously
	td	Setting the display period for the measured value (only when „AddU“ is disabled)
	tu	Setting the display period for the unit (only when „AddU“ is disabled)
	rot	Display direction (0° = standard, 180° = turned)
	decP	Display the decimal places (0...3 fixed decimal places or automatically)
SP		Configuring the switching outputs (when available)
	SP 1 FH 1	Switch point or upper frame limit of switching output 1
	rP 1 FL 1	Reset point or lower frame limit of switching output 1
	dS 1	Output delay at the switch point of switching output 1
	dr 1	Output delay at the reset point of switching output 1
	out 1	Output functions of switching output 1 (Hno, Hnc, Fno, Fnc)
Menu items for switch point 2		
CAL		Calibration menu
	ELr	Adjusting the lower range value (4 mA) to the applied pressure
	EUR	Adjusting the upper range value (20 mA) to the applied pressure
	4mA	Adjusting the current output at 4 mA
	20mA	Adjusting the current output at 20 mA
SYS		System functions
	Loop	Setting a fixed current for test of the loop
	info	Versions of hardware and software, serial number
	rES	Reset to factory settings

● 11 Troubleshooting



- Open pressure connections only after the system is without pressure.
- Take precautions with regard to remaining media in removed pressure transmitters. Remaining media in the pressure port may be hazardous or toxic .
- Remove the pressure sensor from service and mark it to prevent it from being used again accidentally, if it becomes damaged or unsafe for operation.
- Have repairs performed by the manufacturer only.



- Do not insert any pointed or hard objects into the pressure port for cleaning to prevent damage to the diaphragm of the pressure connection.
- Verify in advance if the pressure is being applied (valves / ball valve etc. open) and if the right voltage supply and the right type of wiring has been chosen.

Failure	Possible cause	Procedure
No output signal	Cable break No/incorrect voltage supply or current spike	Check connectors and cable Adjust voltage supply to corresp. with the operating instructions
No/false output signal	Incorrectly wired	Follow pin assignment (see instr. label / operating instructions)
Output signal unchanged after change in pressure	Mechanical overload through overpressure	Replace instrument, if failure reoc consult the supplier
Signal span dropping off / too small	Mechanical overload through overpressure Diaphragm is damaged e. g. through impact, abrasive/corrosive media, corrosion of diaphragm/pressure connector, transmission fluid missing Seal/sealing face damaged/contaminated, seal mounted incorrectly, threads crossed	Replace instrument, if failure reoc consult the supplier Contact the supplier and replace the instrument Clean the seal/sealing face, possibly replace the seal
Signal span erratic/incorrect	Electromagnetic interference source in the vicinity e. g. inverter drive Working temperature too high/ too low Instrument not grounded Violent fluctuations in the process media pressure	Shield the device, shield the cbls, remove the interference source Ensure permissible temperatures as per the operating instructions Ground instrument Damping, consult the supplier
Abnormal zero point signal	Working temperature too high/ too low Abnormal mounting position Overload limits exceeded	Ensure permissible temperatures as per the operating instructions Correct the zero point through the „tLr“ (teach lower range) Ensure permissible overload limits are complied with (see operating instructions)

Note: In case of unjustified reclamation an additional charge is possible.

Make sure that after the setting the unit is working properly. In case the error continues to exist send the instrument for reparation (or replace the unit).

Returned goods: Purge / clean dismantled instruments before returning them in order to protect persons and the environment from any hazard caused by adherent remaining media.

● 12 Technical Data

Input

Pressure: relative: 0...0,1 up to 0...1000 bar / -1...0 bar absolute: 0...0,25 up to 0...16 bar
Pressure ranges: see table page 23 (with overload limit, burst pressure)

Output

Current signal: 4...20 mA with superimposed communication signal (HART), 2-wire current loop
Current range: 3,8...20,5 mA
Signal on error: 3,6 mA (sensor short circuit, underflow)
21 mA (sensor break, sensor open circuit, overflow)

Performance

Sensor: Accuracy: <0,5% of span (at reference conditions)
Including non-linearity, hysteresis, zero and full scale error (corresponds to error of measurement per IEC 61298-2)
Adjustment: in vertical mounting position with lower pressure connection
Non-linearity: <0,2% of span (BFSL per IEC 61298-2)
Non-repeatability: <0,1% of span (per IEC 61298-2)
1-year stability: <0,2% of span (at reference conditions)
Temperature coefficient: mean temperature coefficient (TC) within rated temperature range
TC zero: <0,2% of span / 10 K
<0,4% span / 10 K for ranges <250 mbar
TC span: <0,2% span / 10 K
Reference conditions: 15...25 °C / 860...1060 mbar / 45...75% rH / 24 VDC
Measuring amplifier: Resolution: 16 Bit
Accuracy: 0,3% of range
Filter setting: 0...99 s
Transmission behaviour: linear with pressure
Measuring rate: 10 measurements / s
Configuration: keys on display / via software (HART-communication)
Turn-on delay time: <5 s
Response time: 20 ms
Indicator / limit values: Resolution: -9999...9999 digit
Error of measurement: $\pm 0,2\%$ of range, ± 1 digit
Temperature drift: 100 ppm/K
Features, operation: according VDMA 24574-1 up to 24574-4

Indication

Display: 7 segment, 8,5 mm, red, 4 digits, representation mirror-inverted 180° possible
Head of display: rotatable approx. 330°
Memory: minimum / maximum values
Indication: - measuring value - unit of measurement- control menu
Decimal point: automatically or manually, dependent on measuring range / unit
Representation: xxxx / xxx.x / xx.xx / x.xxx

Limit Contacts

Electronically: 2x NPN or PNP (30 VDC, 200 mA) Option: 2x NPN or PNP (30 VDC, 1000 mA)
Indication: 1 LED red for each limit value
Voltage across: <1 V
Settings: with 3 keys (TouchM-Technology)
Setting range: switch point and hysteresis: any value within measuring range
Switching delay: 0,0...999,9 s
Failsafe function: adjustable
Galvanical insulation: switching outputs are separated from measuring amplifier

Supply

Voltage: HART current loop: 12...40 VDC
Load: $R = (U_B - 12 \text{ V}) / 21 \text{ mA}$
Reverse battery: Protection available (no function, no damage)

● 12 Technical Data (Continued)

Environmental Conditions

Temperature:	Operating range: -20...80 °C 0...+80 °C (nominal range) Storing: -20...+85 °C Medium: -30...+100 °C
Condensation:	uncritical
CE-conformity:	Pressure equipment directive: 2014/68/EU EMC directive: 2014/30/EU
Shock resistance:	1000 g according IEC 60068-2-27 (mechanical shock)
Vibration resistance:	20 g according IEC 60068-2-6 (vibration under resonance)

Mechanics

Dimensions:	see data sheet	
Pressure connection:	G 1/2 (EN837) / G 1/4 (EN837) / G 1/4 (DIN 3852-E) / 1/2 NPT / 1/4 NPT for NPT thread: nominal size for "US standard tapered pipe thread NPT"	
Electrical connection:	see page 6	
Material:	Process connection:	stainless steel CrNi (contact with medium)
	Body:	PBT GF30
	Head of display:	polycarbonate
Transmission fluid:	synthetic oil (internal), no transmission fluids for models with pressure ranges >25 bar	
Weight:	approx. 240 g	
Ingress protection:	Process connection:	at least IP 65 (electronics)
	PCB:	potted

Pressure Table

Pressure range	0,1	0,16	0,25	0,4	0,6	1	1,6	2,5
Overload limit	1	1,5	2	2	4	5	10	10
Burst pressure	2	2	2,4	2,4	4,8	6	12	12
Pressure range	4	6	10	16	25	40	60	100
Overload limit	17	35	35	80	50	80	120	200
Burst pressure	20,5	42	42	96	96	400	550	800
Pressure range	160	250	400	600	1000			
Overload limit	320	500	800	1200	1500			
Burst pressure	1000	1200	1700	2400	3000			

