

DISPLAY PRESSURE SWITCH

Swiss based Trafag is a leading international supplier of high quality sensors and monitoring instruments for measurement of pressure and temperature. The DPC 8380 is the ideal combination of pressure switch and transmitter with pressure display. The parameters are set on the device or in a timesaving way via an NFC - smartphone App. The settings in combination with a comprehensive set of options make the DPC 8380 suitable for a wide range of industrial applications.



Applications

- Machine tools
- HVAC
- Refrigeration
- Water treatment
- Process technology

Features

- Parameterization also via NFC-smartphone App (Android)
- Display and electrical connection are independently rotatable 335°/343°
- Analogue output switchable mA or V
- Integrated datalogger
- Measuring range adjustable

04/2020

Data sheet H72320m

Technical Data			
Measuring principle	Thick-film-on-ceramic	Accuracy @ 25°C typ.	± 0.5 % FS typ.
Measuring range	0 ... 0.2 to 0 ... 100 bar 0 ... 2.5 to 0 ... 1500 psi adjustable	Media temperature	-25°C ... +85°C
Output signal	4 ... 20 mA, 0 ... 5 VDC, 1 ... 6 VDC, 0 ... 10 VDC, switchable mA or V	Ambient temperature	-25°C ... +85°C
NLH @ 25°C (BSL) typ.	± 0.2 % FS typ.	Pressure unit for display	bar, psi, MPa, kPa, mWC, mmWC, inchWC, %, user scale
Switching output	2 transistors PNP	Logger	Ring buffer: 3518 data points Sampling time: 0.1 ... 999.9 s, Off (0)

Subject to change

Ordering information/type code

				8380 . XX				XX	XX	XX	XX	XX
Measuring range ¹⁾	Pressure measurement range [bar]	Over pressure [bar]	Burst pressure [bar]		Pressure measurement range [psi]	Over pressure [psi]	Burst pressure [psi]					
	0 ... 0.2	1.2	2	68	0 ... 2.5	15	30	F8				
	0 ... 0.4	1.2	2	69	0 ... 5	15	30	F9				
	0 ... 0.6	1.2	2	70	0 ... 10	20	30	G0				
	0 ... 1	2	4.8	71	0 ... 15	45	70	G1				
	0 ... 1.6	3.2	4.8	73	0 ... 20	45	70	G3				
	0 ... 2.5	5	7.5	75	0 ... 30	60	90	G5				
	0 ... 4	8	12	76	0 ... 50	100	150	G6				
	0 ... 6	12	15	77	0 ... 100	200	250	G7				
	0 ... 10	20	25	78	0 ... 150	300	375	G8				
	0 ... 16	32	40	79	0 ... 250	500	625	G9				
	0 ... 25	50	75	80	0 ... 400	800	1200	H0				
	0 ... 40	80	100	81	0 ... 500	1000	1250	H1				
	0 ... 60	120	180	82	0 ... 1000	2000	3000	H2				
	0 ... 100	200	300	83	0 ... 1500	3000	4500	H3				
	Sensor	Relative pressure, 1.4305, accuracy: 0.5 %			57	Absolute pressure, 1.4305, accuracy: 0.5 % ³⁾			87			
Relative pressure, 1.4404/1.4435, accuracy: 0.5 % ⁴⁾			59	Absolute pressure, 1.4404/1.4435, accuracy: 0.5 % ^{3) 4)}			89					
Relative pressure, 1.4462, accuracy: 0.5 % ⁴⁾			52	Absolute pressure, 1.4462, accuracy: 0.5 % ^{3) 4)}			82					
Relative pressure, titanium grade 5, accuracy: 0.5 % ⁴⁾			53	Absolute pressure, Titanium Grade 5, accuracy: 0.5 % ^{3) 4)}			83					
Pressure connection	G1/4" female			10	7/16"-20UNF male, DIN3866 ^{3) 4)}			18				
	G1/4" male			17	7/16"-20UNF female, SAE J512 with valve opener ^{3) 4)}			24				
	G1/2" male DIN3852-E ⁴⁾			41	7/16"-20UNF male, SAE4 (J1926) ⁴⁾			42				
	1/4" NPT male ⁴⁾			30	9/16"-18UNF male, SAE6 (J1926), seal: accessory 61 ^{2) 4)}			61				
	R1/4" male, DIN3858 ⁴⁾			19	G3/4" frontal membrane ^{4) 6)}			52				
Electrical connection	Male electrical connector M12x1, 4-pole, Mat. PA (Accessories P3, P4)							32				
	Male electrical connector M12x1, 5-pole, Mat. PA (Accessories P1, P2)							35				
Output signal	Switching output PNP, current output 4 ... 20 mA, switchable to 0 ... 10 VDC; output detail see accessories P1, P2, P3								PA			
	Switching output PNP, voltage output 1 ... 6 VDC; output detail see accessories P1, P2, P3								PU			
	Switching output PNP, voltage output 0 ... 10 VDC; output detail see accessories P1, P2, P3								PV			
	Switching output PNP, voltage output 0 ... 5 VDC; output detail see accessories P1, P2, P3								PW			
	Switching output PNP; output detail see accessory P4								PS			
Accessories	Pin configuration 5-pole.; 1: U+, 2: analogue, 3: U-, 4: SP1, 5: SP2											P1
	Pin configuration 5-pole.; 1: U+, 2: SP2, 3: U-, 4: SP1, 5: analogue											P2
	Pin configuration 4-pole.; 1: U+, 2: analogue, 3: U-, 4: SP1											P3
	Pin configuration 4-pole.; 1: U+, 2: SP2, 3: U-, 4: SP1											P4
	Pressure peak damping element ø 1.0 mm, material 1.4305 ⁷⁾											40
	Pressure peak damping element ø 0.4 mm, material 1.4305 (sensors 57, 87) resp. 1.4404 (sensors 52, 53, 59, 82, 83, 89) ⁷⁾											44
	Seal FPM, -18°C ... +125°C											61
	Seal EPDM, -40°C ... +125°C											63
	Female electrical plug M12x1, 5-pole ⁵⁾											33
	Parameterization standard for output signal PS (see table "Parameters")											Z5
	Parameterization according to customer specification (see table "Parameters")											ZC
	Function package 1: Zero set / Measuring range zero point adjustment											Z1
	Function package 2: User scale unit / analogue output adjustment											Z2
	Protective cap, 1 pc. F89051, package of 5 pcs. F89052, package of 25 pcs. F89075											
Adapter with flange connection, 1 pc. F82054												

¹⁾ Extended overpressure as well as customized pressure ranges upon request

²⁾ Only for sensors 59 and 89

³⁾ Max. 40 bar or 500 psi

⁴⁾ Upon request

⁵⁾ For electrical connections 32 and 35

⁶⁾ Not for sensors 57 and 87, only for pressure ranges ≤ 25 bar or 400 psi

⁷⁾ Not for pressure connections 10, 18, 24, 52

Standard products (extra short lead time)

Product No.	Type Code	Pressure range [bar]	Over pressure max. [bar]	Supply [VDC]	Accuracy @ 25°C typ. [%]
DPC0.2PAP1	8380 68 5717 35 0000 0000 PA P1 44 61 ZS Z1 Z2	0 ... 0.2	1.2	15 ... 30	± 0.5
DPC0.4PAP1	8380 69 5717 35 0000 0000 PA P1 44 61 ZS Z1 Z2	0 ... 0.4	1.2	15 ... 30	± 0.5
DPC0.6PAP1	8380 70 5717 35 0000 0000 PA P1 44 61 ZS Z1 Z2	0 ... 0.6	1.2	15 ... 30	± 0.5
DPC1.0PAP1	8380 71 5717 35 0000 0000 PA P1 44 61 ZS Z1 Z2	0 ... 1	2	15 ... 30	± 0.5
DPC1.6PAP1	8380 73 5717 35 0000 0000 PA P1 44 61 ZS Z1 Z2	0 ... 1.6	3.2	15 ... 30	± 0.5
DPC2.5PAP1	8380 75 5717 35 0000 0000 PA P1 44 61 ZS Z1 Z2	0 ... 2.5	5	15 ... 30	± 0.5
DPC4.0PAP1	8380 76 5717 35 0000 0000 PA P1 44 61 ZS Z1 Z2	0 ... 4	8	15 ... 30	± 0.5
DPC6.0PAP1	8380 77 5717 35 0000 0000 PA P1 44 61 ZS Z1 Z2	0 ... 6	12	15 ... 30	± 0.5
DPC10.0PAP1	8380 78 5717 35 0000 0000 PA P1 44 61 ZS Z1 Z2	0 ... 10	20	15 ... 30	± 0.5
DPC16.0PAP1	8380 79 5717 35 0000 0000 PA P1 44 61 ZS Z1 Z2	0 ... 16	32	15 ... 30	± 0.5
DPC25.0PAP1	8380 80 5717 35 0000 0000 PA P1 44 61 ZS Z1 Z2	0 ... 25	50	15 ... 30	± 0.5
DPC40.0PAP1	8380 81 5717 35 0000 0000 PA P1 44 61 ZS Z1 Z2	0 ... 40	80	15 ... 30	± 0.5
DPC60.0PAP1	8380 82 5717 35 0000 0000 PA P1 44 61 ZS Z1 Z2	0 ... 60	120	15 ... 30	± 0.5
DPC100.0PAP1	8380 83 5717 35 0000 0000 PA P1 44 61 ZS Z1 Z2	0 ... 100	200	15 ... 30	± 0.5

Parameters				
Name	Standard setting (accessory ZS)	Value range	Short name	Customer adjustment (accessory ZC)
Switch point SP1 (hysteresis mode) Upper switch point FH1 (window mode)	75 % Measuring range	SP1 > RP1 FH1 > FL1 Hysteresis ≥ 1 % FS	SP1	
Reset point RP1 (hysteresis mode) Lower switch point FL1 (window mode)	25 % Measuring range	RP1 < SP1 FL1 < FH1 Hysteresis ≥ 1 % FS	RP1	
Switch point SP2 (hysteresis mode) Upper switch point FH2 (window mode)	75 % Measuring range	SP2 > RP2 FH2 > FL2 Hysteresis ≥ 1 % FS	SP2	
Reset point RP2 (hysteresis mode) Lower switch point FL2 (window mode)	25 % Measuring range	RP2 < SP2 FL2 < FH2 Hysteresis ≥ 1 % FS	RP2	
Switch point delay time SP1 (hysteresis mode) Switch point delay time FH1 (window mode)	0	0 ... 99.99 s	dS1	
Switch point delay time RP1 (hysteresis mode) Switch point delay time FL1 (window mode)	0	0 ... 99.99 s	dR1	
Switch point delay time SP2 (hysteresis mode) Switch point delay time FH2 (window mode)	0	0 ... 99.99 s	dS2	
Switch point delay time RP2 (hysteresis mode) Switch point delay time FL2 (window mode)	0	0 ... 99.99 s	dR2	
Functions switching output 1	Hysteresis, closer (Hno)	Hysteresis NO (Hno), Hysteresis NC (Hnc) Window NO (Fno), Window NC (Fnc)	ou1	
Functions switching output 2	Hysteresis, closer (Hno)	Hysteresis NO (Hno), Hysteresis NC (Hnc) Window NO (Fno), Window NC (Fnc)	ou2	
Pressure units	bar	bar, psi, MPa, kPa, mWC, inchWC	uni	
Measuring range adjustment	100 % Nominal pressure	50 ... 100 % Nominal	P_EP	
Damping (analogue output)	0.01 s	0.01 ... 3.00 s (time constant)	dAA	
Display rotation	No	no, yes (180°)	disr	
Display mode	Current pressure value	Pressure value: current, highest, lowest, display off Current value: decimal places selectable (max. 3)	dis	
Display actualisation	2	1, 2, 5, 20 Hz	duPd	

Specifications		
Electrical Data	Output / supply voltage	4 ... 20 mA: 24 (15 ... 30) VDC 0 ... 5 VDC: 24 (15 ... 30) VDC 1 ... 6 VDC: 24 (15 ... 30) VDC 0 ... 10 VDC: 24 (15 ... 30) VDC
	Switch-on-delay	Typ. 200 ms
	Inverse-polarity protection, short-circuit strength @ 25°C during 5 min.	integrated
	Current consumption	≤ 30 mA
Environmental conditions	Media temperature	-25°C ... +85°C
	Ambient temperature	-25°C ... +85°C
	Protection ¹⁾	IP67
	Humidity	Max. 95 % relative
	Vibration	10 g (10 ... 2000 Hz)
	Shock	50 g / 3 ms
EMC Protection	Emission	EN/IEC 61000-6-3
	Immunity	EN/IEC 61000-6-2
Mechanical Data	Sensor (wetted parts)	Ceramic, Al ₂ O ₃ (96 %)
	Pressure connection (wetted parts)	57/87: 1.4305 (AISI303) 59/89: 1.4404/1.4435 (AISI316L) 52/82: 1.4462 (AISI318LN) 53/83: Titanium Grade 5
	Housing	Zinc based die-casting alloy, nickel plated display housing plastic
	Sealing	FPM, EPDM
	Male electrical connector	See ordering information
	Weight	~ 189 g
	Mounting torque	15 ... 20 Nm
	Housing alignment	Display 335° rotatable, max. 2.5 Nm Electrical connection 343° rotatable, max. 5 Nm

¹⁾ See electrical connection

Measuring accuracy 0.5 %

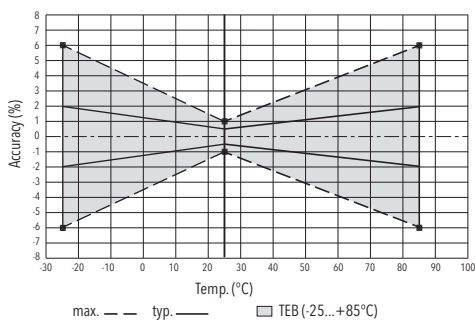

Analogue output			
Output signal	Switchable 4 ... 20 mA or voltage		
Accuracy	TEB @ -25 ... +85°C	[% FS typ.]	± 2.0
	Accuracy @ +25°C	[% FS typ.]	± 0.5
	NLH @ +25°C (BSL)	[% FS typ.]	± 0.2
	TC zero point and span	[% FS/K typ.]	± 0.03
	Long term stability 1 year	[% FS typ.]	± 0.3
Current limiting output signal	4 ... 20 mA: 25 mA (overload)		
	0 ... 10 VDC: < 40 mA (short-circuit)		
Damping (rise time)	0.01 ... 3.00 s / 10 ... 90 % Nominal pressure		
Zero set; ¹⁾	± 0.2 % FS		
Offset correction of analogue output and display indication			
Measuring range zero point adjustment (P_nP) ¹⁾	0 ... 50 % FS ²⁾		
Measuring range end point adjustment (P_EP)	50 ... 100 % FS ²⁾		
Zero point adjustment analogue output (o_nP) ¹⁾	Voltage output: 0 ... 2 VDC Current output: 3.9 ... o_EP - 8 mA		
End point adjustment analogue output (o_EP) ¹⁾	Voltage output: o_nP + 4 ... 10.5 VDC Current output: o_nP + 8 ... 20.1 mA		

¹⁾ Available with optional function package, see "Accessories"

²⁾ P_EP - P_nP ≥ 50 % FS

Switching output			
Accuracy	Accuracy @ +25°C	[% FS typ.]	± 0.5
	TEB @ -25 ... +85°C	[% FS typ.]	± 2.0
	Long term stability 1 year	[% FS typ.]	≤ ± 0.3
Adjustment range of switchpoints	0 ... 100 % FS		
Switching hysteresis	≥ 1 % FS		
	Switchpoint > reset point		
Switching resistance	≤ 3 Ω		
Output function	Hysteresis, Window; normally closed (NO), normally open (NC)		
Switching current	≤ 0.5 A each switching output		
Current limiting	≤ 2 A each switching output		
Switching frequency	max. 200 Hz		
Delay time	0 ... 99.99 s		

Display	
Display	4-digit 7-segment display 180° flippable with disable function Standard decimal places: ≤ 9: 3 decimal places 10 ... 99: 2 decimal places 100 ... 999: 1 decimal place
Switching status indication	2 LED, red
Operation	With 3 buttons and menu navigation according to VDMA 24574-1
Display resolution	0.1 % FS
Display range	-3 ... 103 % FS
Setting parameters	See table Parameters
User scale unit;	Display zero point: -999 ... 9998
User defined values for display indication zero point and end point ¹⁾	Display end point: -998 ... 9999

¹⁾ Available with optional function package, see "Accessories"

Dimensions

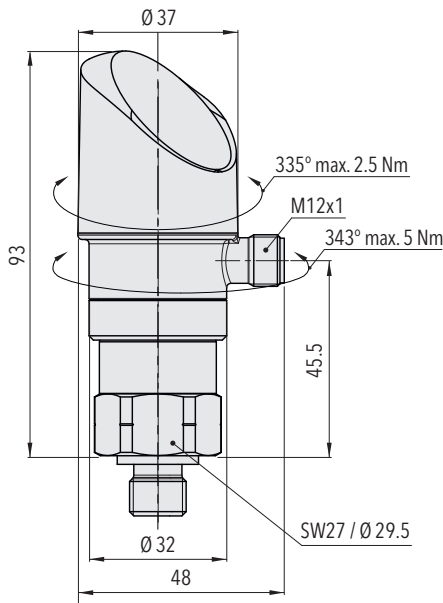

8380.XX.XXXX.35/32.XX.XX

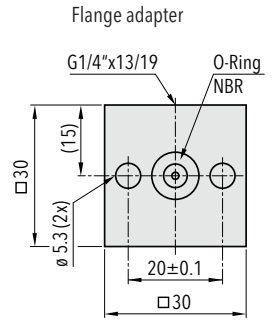
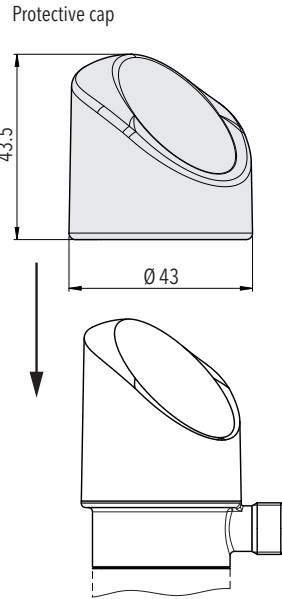

F82054

Mounting accessory included

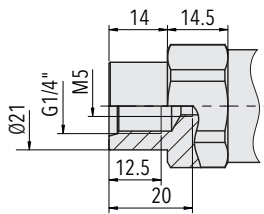

8380.XX.XX10.XX.XX.XX

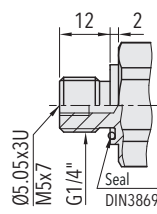

8380.XX.XX17.XX.XX.XX

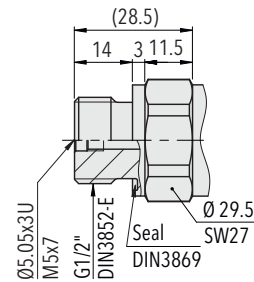

8380.XX.XX41.XX.XX.XX

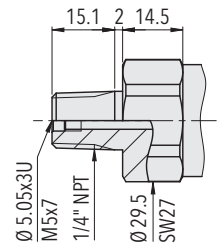

8380.XX.XX30.XX.XX.XX

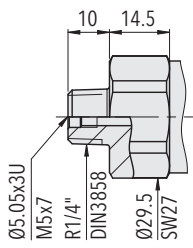

8380.XX.XX19.XX.XX.XX

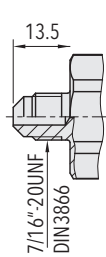

8380.XX.XX18.XX.XX.XX

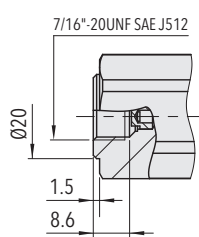

8380.XX.XX24.XX.XX.XX

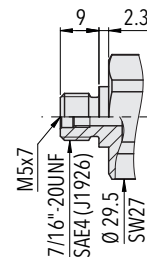

8380.XX.XX42.XX.XX.XX

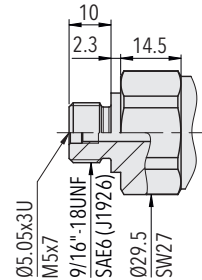

8380.XX.XX61.XX.XX.XX

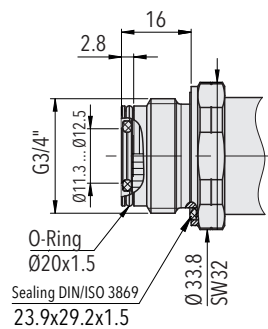
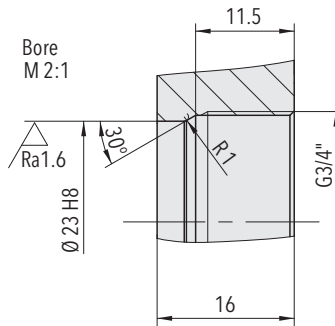

8380.XX.XX52.XX.XX.XX

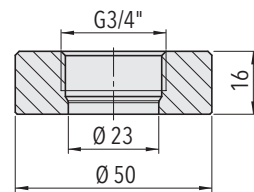

Welding flange for G3/4" frontal membrane (1.4301)
Ordering No. C27805

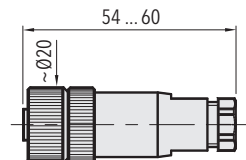

8380.XX.XXXX.XX.XX.33

Electrical connection

		Protection / electrical connection			
		IP67*)			
		M12x1			
		5-pole 35		4-pole 32	
Output signal		P1	P2	P3	P4
	PA	✓	✓	✓	
	PU	✓	✓	✓	
	PV	✓	✓	✓	
	PW	✓	✓	✓	
	PS				✓
Pin Configuration		P1	P2	P3	P4
	U _S + U _S - Out analogue SP1 SP2 Shield *** 8380.xx.XXXX.xx.PA/PU/PV/PW/PS	1 3 2 4 5 Shield ***	1 3 5 4 2 Shield ***	1 3 2 4 Shield ***	1 3 - 4 2 Shield ***

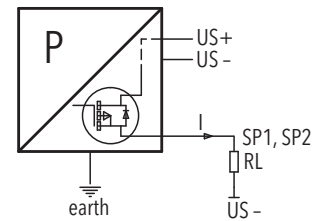

Connection of loads to switching output

*) Provided female electrical plug is mounted according to instructions

***) The use of a shielded cable is recommended

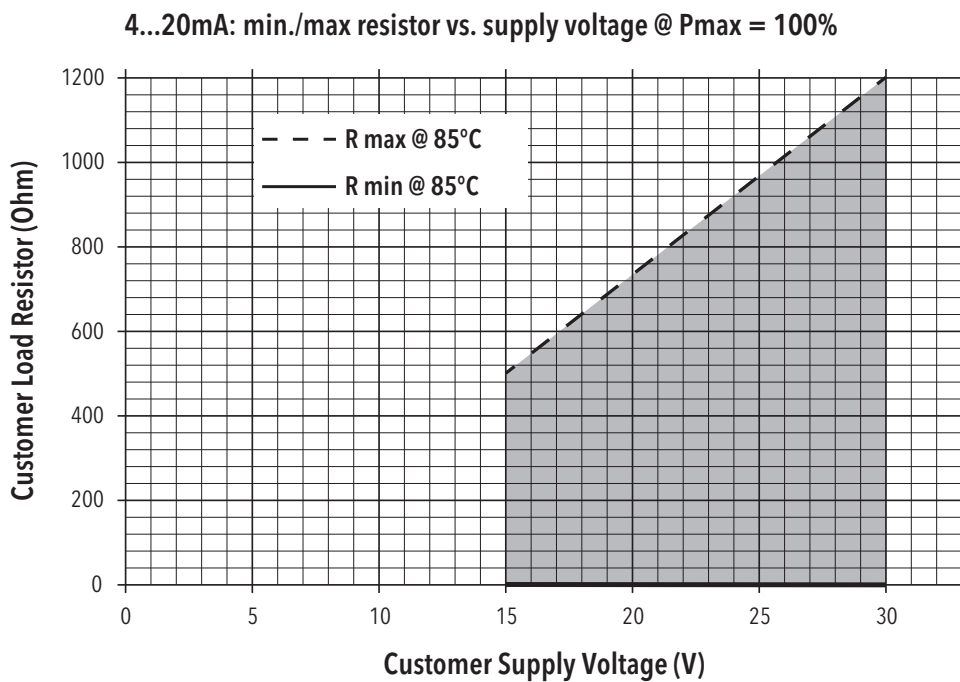

Functions switching output

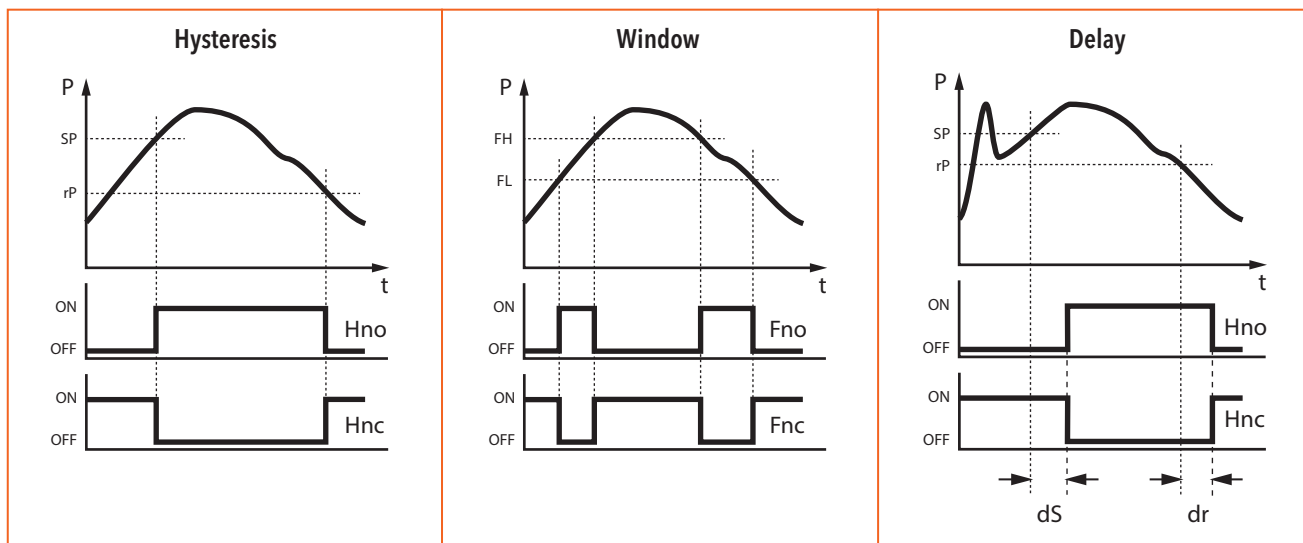

Additional information

Documents

Data sheet	www.trafag.com/H72320
Instructions	www.trafag.com/H73320
Flyer	www.trafag.com/H70691